

TECTUS®

The completely concealed hinge system



INDEX

TECTUS® – THE COMPLETELY CONCEALED HINGE SYSTEM

Model versions from 60 to 300 kg		
14	TE 240 3D	60 kg for unrebated and rebated flush residential doors
15	TE 340 3D	80 kg for unrebated residential and heavy-duty doors
16	TE 526 3D	120 kg made of solid stainless steel for unrebated heavy-duty doors
17	TE 527 3D	120 kg made of solid steel for unrebated heavy-duty doors
18	TE 540 3D	120 kg for unrebated heavy-duty doors
19	TE 640 3D	200 kg for unrebated high performance heavy-duty doors
20	TE 645 3D	300 kg for unrebated high performance heavy-duty doors

Model versions for special applications		
24	TECTUS® A8	for unrebated high performance heavy-duty doors with claddings up to 8 mm
26	TECTUS® Energy	with permanent energy transfer
28	TECTUS FVZ	for unrebated residential and heavy-duty doors with recessed frame facings
30	TE 380 3D	60 kg for rebated residential doors
32	TE 680 3D FD	160 kg for rebated entrance doors
34	TECTUS® FR	with integrated intumescent kit

Fixing plates and receivers		
36	TE 640 3D BW	fixing angle for heavy-duty doors on block frames
37	TE ... 3D FZ	fixing plate for heavy-duty doors on casing frames
38	TE ... 3D SZ	receiver for residential and heavy-duty doors on steel frames
39	TE ... 3D ST	receiver for residential and heavy-duty steel doors

40	Assembly
----	-----------------

44	Routing data
----	---------------------

54	Service
----	---------

TECTUS® – THE COMPLETELY CONCEALED HINGE SYSTEM

"Making something invisible is also design!" There is a certain appeal in designing items in such a way that their actual value is initially in the background, thereby giving space to other elements. Flush mounting is a stylistic principle that exudes minimalism and involves precise technology and perfection. The TECTUS series of concealed hinges offers unsurpassed quality, versatility and depth. The completely concealed hinge system TECTUS has been an integral part of the SIMONSWERK range since 2002. Thanks to its ongoing development, TECTUS is today more innovative and efficient than ever.

TECTUS® – THE ADVANTAGES AT A GLANCE

- › completely concealed hinge system
 - › for flush-fitting architectural structures
 - › with load capacity of 60 to 300 kg
 - › comfortable 3D adjustment
 - › with an opening angle of 180°
 - › for unrebated and rebated flush doors
 - › for rebated doors
 - › for timber, steel and aluminium frames
 - › with maintenance-free slide bearing technology
-



TECTUS – MODEL VERSIONS FROM 60 TO 300 KG

TECTUS hinges have impressive load-bearing capacities, being able to support door elements of up to 300 kg. They also have an opening angle of up to 180° and can be used with wood, steel and aluminium frames. The hinges can be adjusted in all three dimensions and require no maintenance. They are used on high-quality residential doors and functional heavy-duty doors in public buildings.

The wide range of finishes enables a variety of applications – they can be harmoniously tailored to an architectural concept and fittings and can completely blend into the background when the respective door is closed.





TECTUS ENERGY – FOR PERMANENT ENERGY TRANSFER

TECTUS Energy enables permanent energy transfer, without compromising on the design aspect of surface-flush appearances. It combines design, function and technology in an exemplary way and creates opportunities for new ideas. For fitting and operating electronic components in high-quality heavy-duty doors, the safe and permanent energy transfer is decisively important. TECTUS Energy secures the door leaf and permanently provides energy from the side of the frame without weakening the door or frame geometry. The technology provided together with TECTUS Energy offers compatibility with all standard versions of locks and fittings, while retaining all technical and optical features of the TECTUS product brand.

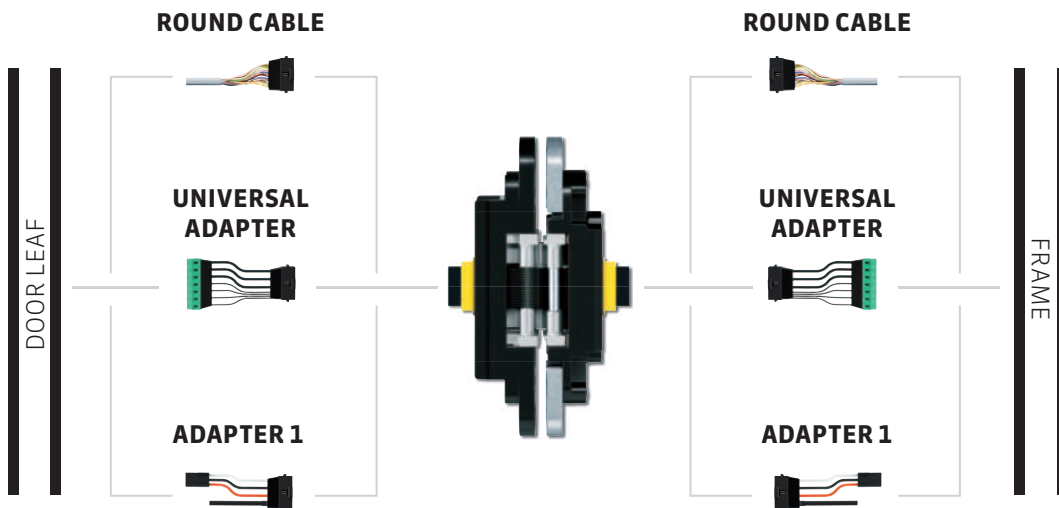

Großer Saal
2. Rang rechts

Rangfoyer

2008
Hauptstadt der
Landeshauptstadt
Dresden
Hauptstadt der
Landeshauptstadt
Dresden
Hauptstadt der
Landeshauptstadt
Dresden

MODEL VERSIONS FOR SPECIAL APPLICATIONS

TECTUS FVZ – For doors with recessed frame facings

With TECTUS FVZ, a design where the frame part is offset to the sash part, it is possible to integrate a door with a completely concealed hinge into the surrounding wall without any visible frame. The frame facing can be set back by 12 or 14 mm, to allow the door and wall sets to create a flush-fitting whole.

TECTUS FR – With integrated intumescent kit

The TECTUS FR model version is equipped with an integrated intumescent kit. Whilst maintaining all routing dimensions and optical features of the TECTUS, they provide the perfect basis for use on fire-resistant door elements. In case of a fire, the intumescent kit swells, sealing the door around the hinges, thereby protecting against fire and smoke escaping into a neighbouring room.



MODEL VERSIONS FOR SPECIAL APPLICATIONS

TECTUS A8 – For claddings up to 8 mm

The “A8” versions provide new application possibilities as they can accommodate claddings of up to 8 mm on the door and frame construction. This gives the designer more scope when integrating the door element into the overall interior design concept.

TECTUS Rebate – For rebated residential and entrance doors

With TECTUS TE 680 3D FD, SIMONSWERK offers a new model version as a solution for conventionally rebated timber entrance doors. Easy mounting and convenient 3D adjustment make installation easy, while a circumferential seal ensures the required level of impermeability around the hinges. The innovative hinge system for timber entrance doors further impresses with a load capacity of 160 kg. For rebated residential doors SIMONSWERK offers the TECTUS TE 380 3D. The concealed hinge system is completely invisible when the door is closed. The hinge joint's special geometry allows for installation in the rebated door leaf with a receiver in the wood, steel or aluminium frame.



DESIGN MEETS FUNCTION

A FULL RANGE OF CONCEALED HINGES

For applications ranging from high-quality interior doors to heavy-duty doors with special requirements in terms of load capacity and performance, SIMONSWERK has for years provided a comprehensive product range including a wide choice of its completely concealed TECTUS brand.

All the models in the TECTUS brand completely concealed hinge range for high-quality interior and functional heavy-duty doors have the same technical and visual features, and can be used with timber, steel and aluminium frames. They all have a uniform appearance, with a closed hinge body that hides the milling from view, and are available in a range of materials and attractive surface finishes.



TE 240 3D

load capacity
up to 60 kg



TE 340 3D

load capacity
up to 80 kg



**Versions for special applications
from page 22.**



TE 526 3D

load capacity
up to 120 kg



TE 527 3D

load capacity
up to 120 kg



TE 540 3D

load capacity
up to 120 kg



TE 640 3D

load capacity
up to 200 kg



TE 645 3D

load capacity
up to 300 kg

TECTUS®

TE 240 3D

for unrebated and rebated flush residential doors

hinge up to 60 kg

Product features

- completely concealed hinge system
- for timber, steel or aluminium frames
- for unrebated and rebated flush residential doors
- sideways closed hinge body for a homogeneous mortise appearance
- 3D adjustment (side +/- 3.0 mm, height +/- 3.0 mm, compression +/- 1.5 mm)
- maintenance-free slide bearings

Technical details

load capacity	i two hinges per door leaf (1x2m)	60.0 kg
overall length		155.0 mm
width (frame part)		21.0 mm
width (door part)		18.0 mm
cutter diameter		16.0 mm
opening angle		180°

Finishes

Satin Chrome Look (F1) (124), Satin Nickel Look (F2) (125), Stainless Steel Look (SSL) (126), polished brass (030), polished nickelled (038), Bronze Finish (174), Bronze Finish Light (175), Bronze Finish Dark (176), coloured (079), other finishes available upon request

Combination

receiver	casing frame	TE 240 3D FZ/1
	steel frame	TE 240 3D SZ
	steel door	TE 240 3D ST

Installation tools

jig		universal milling frame
frame	template	No. 5 250691 6
door	template	No. 5 250692 6

Detailed information in our PRODUCTSELECTOR at www.simonswerk.com

Note

i The load capacity mentioned above refers to the use of two hinges per door leaf (1 x 2 m).

With an opening position of 180° the door may have to be fixed additionally.

Classification key

2	7	2	0	1	*	0	7
---	---	---	---	---	---	---	---

*depending on the finish

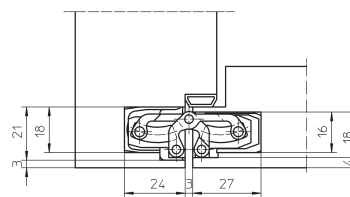
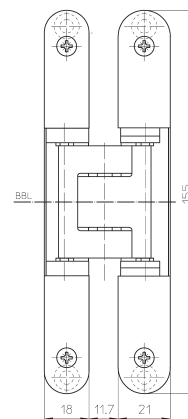

TECTUS®

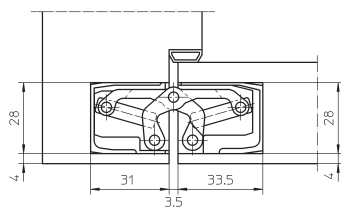
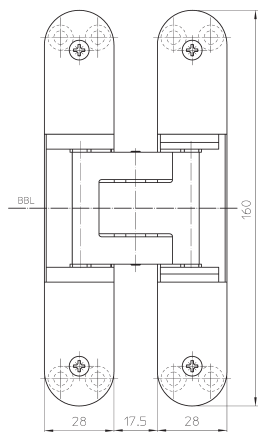

TE 340 3D

for unrebrated residential and heavy-duty doors

hinge		up to 80 kg
-------	--	-------------

Product features

- completely concealed hinge system
- for timber, steel or aluminium frames
- for unrebrated residential and heavy-duty doors
- sideways closed hinge body for a homogeneous mortise appearance
- comfortable 3D adjustment (side +/- 3.0 mm, height +/- 3.0 mm, compression +/- 1.0 mm)
- maintenance-free slide bearings

Technical details

load capacity	i two hinges per door leaf (1x2m)	80.0 kg
overall length		160.0 mm
width (frame part)		28.0 mm
width (door part)		28.0 mm
cutter diameter		24.0 mm
opening angle		180°

Finishes

Satin Chrome Look (F1) (124), Satin Nickel Look (F2) (125), Stainless Steel Look (SSL) (126), polished brass (030), polished nickelled (038), Bronze Finish (174), Bronze Finish Light (175), Bronze Finish Dark (176), coloured (079), other finishes available upon request

Combination

receiver	casing frame	TE 340 3D FZ
	steel frame	TE 340 3D SZ
	steel door	TE 340 3D ST

Installation tools

jig		universal milling frame
step 1	template	No. 5 250693 5
step 2	template	No. 5 250694 5

Detailed information in our PRODUCTSELECTOR at www.simonswerk.com

Functional areas

fire resistance, smoke resistance, burglar resistance

Note

i The load capacity mentioned above refers to the use of two hinges per door leaf (1 x 2 m).

With an opening position of 180° the door may have to be fixed additionally.

Classification key

3	7	4	1	1	*	0	11
---	---	---	---	---	---	---	----

*depending on the finish

QUALITY MARKS



FUNCTIONAL AREAS



TECTUS®

TE 526 3D

made of solid stainless steel for unrebated heavy-duty doors

hinge up to 120 kg

Product features

- material stainless steel
- completely concealed hinge system
- for timber, steel or aluminium frames
- for unrebated heavy-duty doors
- 3D adjustment (side +/- 3.0 mm, height +/- 3.0 mm, compression +/- 1.0 mm)
- maintenance-free slide bearings

Technical details

load capacity	i two hinges per door leaf (1x2m)	120.0 kg
overall length		155.0 mm
width (frame part)		26.0 mm
width (door part)		26.0 mm
cutter diameter		24.0 mm
opening angle		180°

Finishes

Satin Stainless Steel (040), pol. Stainless Steel (042), coloured (079)

Combination

receiver	casing frame	TE 526/527 3D FZ/1
	steel frame	TE 526/527 3D SZ
	steel door	TE 526/527 3D ST

Installation tools

jig universal milling frame
drilling jig TECTUS TE 526 3D

frame / door template No. 5 250547 6

Detailed information in our PRODUCTSELECTOR at www.simonswerk.com

Functional areas

fire resistance, smoke resistance, soundproof, burglar resistance

Note

i The load capacity mentioned above refers to the use of two hinges per door leaf (1 x 2 m).

With an opening position of 180° the door may have to be fixed additionally.

Also available in Satin Stainless Steel grade 316.

Classification key

4	7	6	1	1	4	0	13
---	---	---	---	---	---	---	----

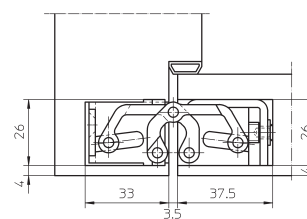
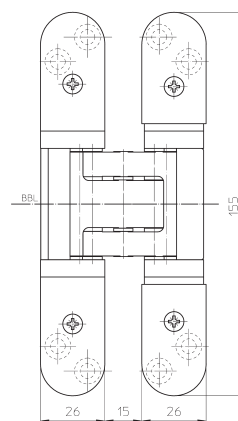

TECTUS®



TE 527 3D

made of solid steel for unrebated heavy-duty doors

hinge		up to 120 kg
-------	--	--------------

Product features

- material solid steel
- completely concealed hinge system
- for timber, steel or aluminium frames
- for unrebated heavy-duty doors
- 3D adjustment (side +/- 3.0 mm, height +/- 3.0 mm, compression +/- 1.0 mm)
- maintenance-free slide bearings

Technical details

load capacity	i two hinges per door leaf (1x2m)	120.0 kg
overall length		155.0 mm
width (frame part)		26.0 mm
width (door part)		26.0 mm
cutter diameter		24.0 mm
opening angle		180°

Finishes

Stainless Steel Look (SSL) (126), coloured (079), other finishes available upon request

Combination

receiver	casing frame	TE 526/527 3D FZ/1
	steel frame	TE 526/527 3D SZ
	steel door	TE 526/527 3D ST

Installation tools

jig		universal milling frame drilling jig TECTUS TE 527 3D
frame / door	template	No. 5 250547 6

Detailed information in our PRODUCTSELECTOR at www.simonswerk.com

Functional areas

fire resistance, smoke resistance, soundproof, burglar resistance

Note

i The load capacity mentioned above refers to the use of two hinges per door leaf (1 x 2 m).

With an opening position of 180° the door may have to be fixed additionally.

Classification key

4	7	6	1	1	*	0	13
---	---	---	---	---	---	---	----

*depending on the finish

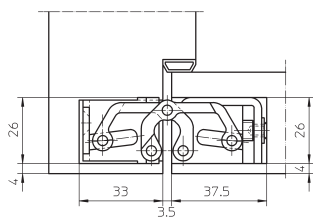
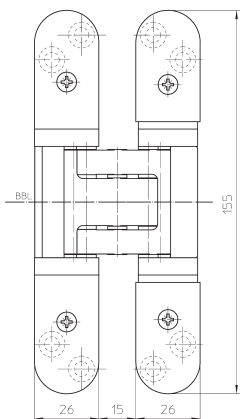

TECTUS®

TE 540 3D

for unrebated heavy-duty doors

hinge up to 120 kg

Product features

- completely concealed hinge system
- for timber, steel or aluminium frames
- for unrebated heavy-duty doors
- sideways closed hinge body for a homogeneous mortise appearance
- comfortable 3D adjustment (side +/- 3.0 mm, height +/- 3.0 mm, compression +/- 1.0 mm)
- maintenance-free slide bearings

Technical details

load capacity	i two hinges per door leaf (1x2m)	120.0 kg
overall length		200.0 mm
width (frame part)		32.0 mm
width (door part)		32.0 mm
cutter diameter		24.0 mm
opening angle		180°

Finishes

Satin Chrome Look (F1) (124), Satin Nickel Look (F2) (125), Stainless Steel Look (SSL) (126), polished brassed (030), polished nickelled (038), Bronze Finish (174), Bronze Finish Light (175), Bronze Finish Dark (176), coloured (079), other finishes available upon request

Combination

receiver	casing frame	TE 540 3D FZ/1
	steel frame	TE 540 3D SZ
	steel door	TE 540 3D ST

Installation tools

jig		universal milling frame
step 1	template	No. 5 250680 5
step 2	template	No. 5 250681 5

Detailed information in our PRODUCTSELECTOR at www.simonswerk.com

Functional areas

fire resistance, smoke resistance, soundproof, burglar resistance

Note

i The load capacity mentioned above refers to the use of two hinges per door leaf (1 x 2 m).

With an opening position of 180° the door may have to be fixed additionally.

Classification key

4	7	6	1	1	*	1	13
---	---	---	---	---	---	---	----

*depending on the finish

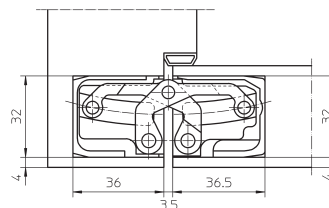
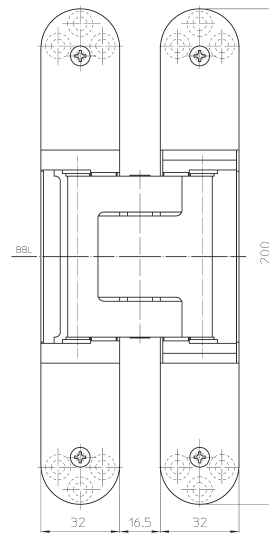

QUALITY MARKS



FUNCTIONAL AREAS



TECTUS®



TE 640 3D

for unrebated high performance heavy-duty doors

hinge		up to 200 kg
-------	--	--------------

Product features

- completely concealed hinge system
- for timber, steel or aluminium frames
- for unrebated high performance heavy-duty doors
- sideways closed hinge body for a homogeneous mortise appearance
- comfortable 3D adjustment (side +/- 3.0 mm, height +/- 3.0 mm, compression +/- 1.0 mm)
- maintenance-free slide bearings

Technical details

load capacity	i two hinges per door leaf (1x2m)	200.0 kg
overall length		240.0 mm
width (frame part)		32.0 mm
width (door part)		32.0 mm
cutter diameter		24.0 mm
opening angle		180°

Finishes

Satin Chrome Look (F1) (124), Satin Nickel Look (F2) (125), Stainless Steel Look (SSL) (126), polished brass (030), polished nickelled (038), Bronze Finish (174), Bronze Finish Light (175), Bronze Finish Dark (176), coloured (079), other finishes available upon request

Combination

receiver	block frame	TE 640 3D BW
	casing frame	TE 640 3D FZ/1
	steel frame	TE 640 3D SZ
	steel door	TE 640 3D ST

Installation tools

jig		universal milling frame
step 1	template	No. 5 250659 5
step 2	template	No. 5 250689 5

Detailed information in our PRODUCTSELECTOR at www.simonswerk.com

Functional areas

fire resistance, smoke resistance, soundproof, burglar resistance

Note

i The load capacity mentioned above refers to the use of two hinges per door leaf (1 x 2 m). Also the load capacities of the respective combined receiver have to be taken into consideration.

With an opening position of 180° the door may have to be fixed additionally.

Classification key

4	7	6	1	1	*	1	14
---	---	---	---	---	---	---	----

*depending on the finish

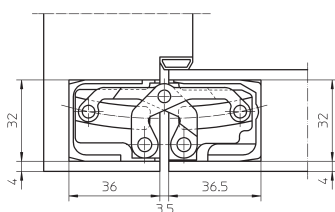
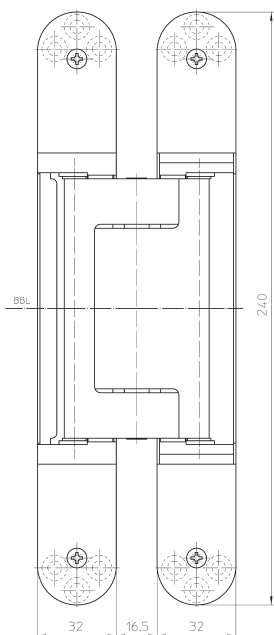

QUALITY MARKS



FUNCTIONAL AREAS



TECTUS®

TE 645 3D

for unrebated high performance heavy-duty doors

hinge up to 300 kg

Product features

- completely concealed hinge system
- for timber, steel or aluminium frames
- for unrebated high performance heavy-duty doors
- sideways closed hinge body for a homogeneous mortise appearance
- comfortable 3D adjustment (side +/- 3.0 mm, height +/- 3.0 mm, compression +/- 1.0 mm)
- maintenance-free slide bearings

Technical details

load capacity	i two hinges per door leaf (1x2m)	300.0 kg
width (frame part)		36.0 mm
width (door part)		34.0 mm
length (frame part)		280.0 mm
length (door part)		260.0 mm
cutter diameter		24.0 mm
opening angle		180°

Finishes

Satin Chrome Look (F1) (124), Satin Nickel Look (F2) (125), Stainless Steel Look (SSL) (126), other finishes available upon request

Combination

receiver	steel frame	TE 645 3D SZ
	steel door	TE 645 3D ST

Installation tools

jig		universal milling frame lang
frame, step 1	template	No. 5 250945 5
frame, step 2	template	No. 5 250946 5
door, step 1	template	No. 5 250947 5
door, step 2	template	No. 5 250948 5

Detailed information in our PRODUCTSELECTOR at www.simonswerk.com

Functional areas

fire resistance, smoke resistance, soundproof, burglar resistance

Note

i The load capacity mentioned above refers to the use of two hinges per door leaf (1x2 m).

Also the load capacities of the respective combined receiver have to be taken into consideration.

Application on steel frames is subject to special frame facings.

With an opening position of 180° the door may have to be fixed additionally.

Classification key

4	7	7	1	1	4	1	14
---	---	---	---	---	---	---	----

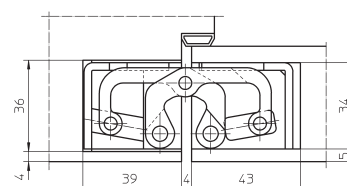
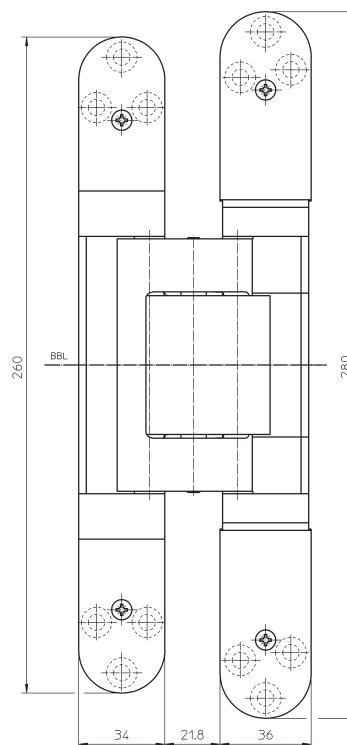



TECTUS®

VERSIONS FOR SPECIAL APPLICATIONS

Special architectural situations, problematic spatial challenges or unusual planning tasks require individual solutions. The solutions presented here by SIMONSWERK complete the TECTUS product range.



TECTUS® A8

for doors with claddings up to 8 mm
load capacities of 100 to 300 kg



TECTUS® Energy

with permanent energy transfer
load capacities of 60 to 300 kg



TECTUS® FVZ

for constructions with recessed
frame facings
load capacities of 60 to 100 kg



TECTUS® rebated

for rebated doors
load capacities up to 60 kg



TECTUS® TE 680 3D FD

for rebated timber entrance doors
load capacities up to 160 kg



TECTUS® FR

with integrated intumescent kit
load capacities of 80 to 200 kg

TECTUS® A8 CLADDING ON THE DOOR AND FRAME CONSTRUCTION

“A8” versions provide new application possibilities as they can accommodate claddings of up to 8 mm on the door and frame construction. This gives the designer more scope when integrating the door set into the overall interior design concept.

load capacity up to 300 kg

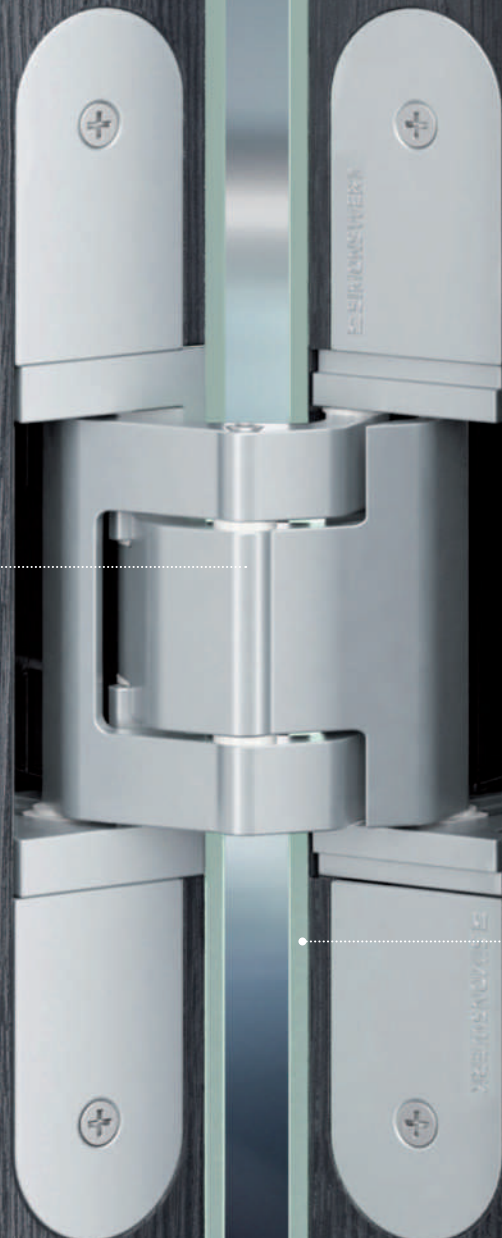

for claddings on door and frame
of up to 8 mm

The use of different materials
such as wood, glass, etc are
possible within door and frame
construction

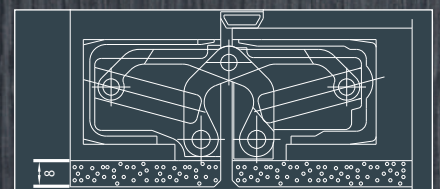

TECTUS®



e.g. TE 540 3D A8

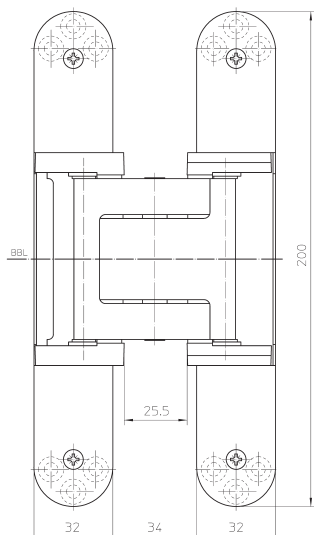

e.g. TE 540 3D A8

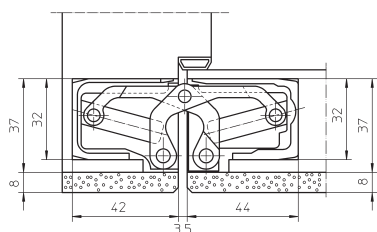

e.g. TE 540 3D A8

TECTUS A8

for unrebated heavy-duty doors with claddings up to 8 mm

hinge	cladding	100 – 300 kg
-------	----------	--------------

Product features

- claddings up to 8 mm
- completely concealed hinge system
- for timber, steel or aluminium frames
- for unrebated heavy-duty doors
- sideways closed hinge body for a homogeneous mortise appearance
- comfortable 3D adjustment (side +/- 3.0 mm, height +/- 3.0 mm, compression +/- 1.0 mm)
- maintenance-free slide bearings

Finishes

Satin Stainless Steel (040) (TE 626 3D A8 only), Satin Chrome Look (F1) (124), Satin Nickel Look (F2) (125), Stainless Steel Look (SSL) (126), polished brass (030), polished nickelled (038), Bronze Finish (174), Bronze Finish Light (175), Bronze Finish Dark (176), coloured (079), other finishes available upon request

Combination

receiver	casing frame	TE ... 3D FZ/1
	steel frame	TE ... 3D A8 SZ
	steel door	TE ... 3D A8 ST
accessories	cover plate set	TE 540/640 3D A8 radius

Functional areas

fire resistance, smoke resistance, soundproof, burglar resistance

Note

i The load capacity mentioned above refers to the use of two hinges per door leaf (1 x 2 m).

With an opening position of 180° the door may have to be fixed additionally.

Classification key

4	7	5	1	1	*	1	12a
---	---	---	---	---	---	---	-----

*depending on the finish

Available options

load capacity up to 100 kg	TE 540 3D A8
	TE 540 3D A8 Energy
load capacity up to 160 kg	TE 640 3D A8
	TE 640 3D A8 Energy
load capacity up to 300 kg	TE 626 3D A8
	TE 626 3D A8 Energy

Detailed information in our PRODUCTSELECTOR at www.simonswerk.com

QUALITY MARKS



FUNCTIONAL AREAS



TECTUS® ENERGY INTEGRATED AND PERMANENT ENERGY TRANSFER

Energy transfer is crucially important in the installation and operation of electric components in high-quality doors. With TECTUS Energy, the door leaf receives a guaranteed and permanent energy supply from the frame, without weakening the structure of either the door or the frame. The technology provided by TECTUS Energy offers compatibility with all the most popular designs for locks and fittings.



CLIP

- › secure connection between cable and hinge housing
- › high functional reliability and fitness for purpose thanks to a closed system

ADAPTER TECHNOLOGY

- › compatibility with all the most popular designs for locks and fittings
- › three different plug connections (round cable, universal adapter, adapter 1)''

FLAT RIBBON CABLE

- › 16-wire ribbon cable
- › integrated permanent energy transfer
- › entirely enclosed in the housing (closed system)

TECTUS®

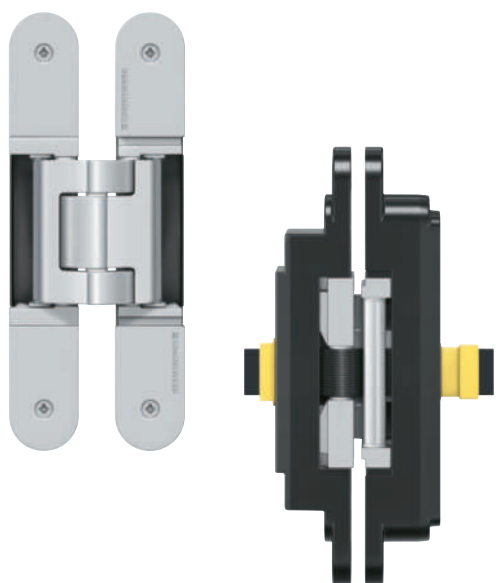

e.g. TE 540 3D Energy

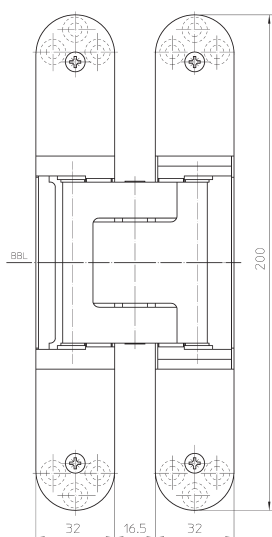

e.g. TE 540 3D Energy

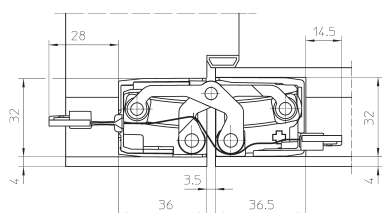

e.g. TE 540 3D Energy

TECTUS Energy

with permanent energy transfer for unrebated heavy-duty doors

hinge	energy transfer	60 – 300 kg
-------	-----------------	-------------

Product features

- with permanent energy transfer
- individual connection adapter options
- completely concealed hinge system
- for timber, steel or aluminium frames
- for unrebated heavy-duty doors
- 3D adjustment (side +/- 3.0 mm, height +/- 3.0 mm, compression +/- 1.0 mm)
- maintenance-free slide bearings

Technical details

no. of wires/wire cross section	16 pieces/0,14 mm ²
max. voltage	50 V (voltage source acc. SELV-DIN EN 61140)
max. current	0,8 A (per wire)
opening angle	180°

Finishes

Satin Stainless Steel (040) (TE 526 3D Energy and TE 626 3D A8 Energy only), Satin Chrome Look (F1) (124), Stainless Steel Look (SSL) (126), other finishes available upon request

Combination

receiver	casing frame	TE ... 3D FZ
	steel frame	TE ... 3D SZ
	steel door	TE ... 3D ST
accessories	round cable	16 x 0.8 A power universal use for all applications cable lengths 3 m or 10 m
		torsion-proof and snap-fitting connection system
	universal adapter	3 x 3.2 A and 4 x 0.8 A power for direct connection of different power collectors
	adapter 1	3 x 3.2 A and 4 x 0.8 A power
		special adapter for connecting FUHR motor locks

Functional areas

fire resistance, smoke resistance, soundproof, burglar resistance

Note

i The load capacity refers to the use of 2 hinges per door leaf (1 x 2 m). Please specify accessories when ordering.

Classification key

4	7	6	1	1	*	1	13
---	---	---	---	---	---	---	----

*depending on the finish

Available options

load capacity up to 60 kg	TE 240 3D Energy
load capacity up to 80 kg	TE 340 3D Energy
load capacity up to 100 kg	TE 540 3D A8 Energy
load capacity up to 120 kg	TE 526 3D Energy
	TE 540 3D Energy
load capacity up to 160 kg	TE 640 3D A8 Energy
load capacity up to 200 kg	TE 640 3D Energy
load capacity up to 300 kg	TE 645 3D Energy
	TE 626 3D A8 Energy

Detailed information in our PRODUCTSELECTOR at www.simonswerk.com

QUALITY MARKS

FUNCTIONAL AREAS



TECTUS® FVZ

INTEGRATION OF DOOR SET INTO SURROUNDING WALL WITHOUT A VISIBLE FRAME

The model versions TECTUS FVZ where the frame part is offset to the leaf part enables a door with a completely concealed hinge to be integrated into the surrounding wall without any visible frame. The frame facing can be set back by 12 or 14 mm, to allow the door and wall sets to create a flush-fitting whole.

load capacity up to 100 kg

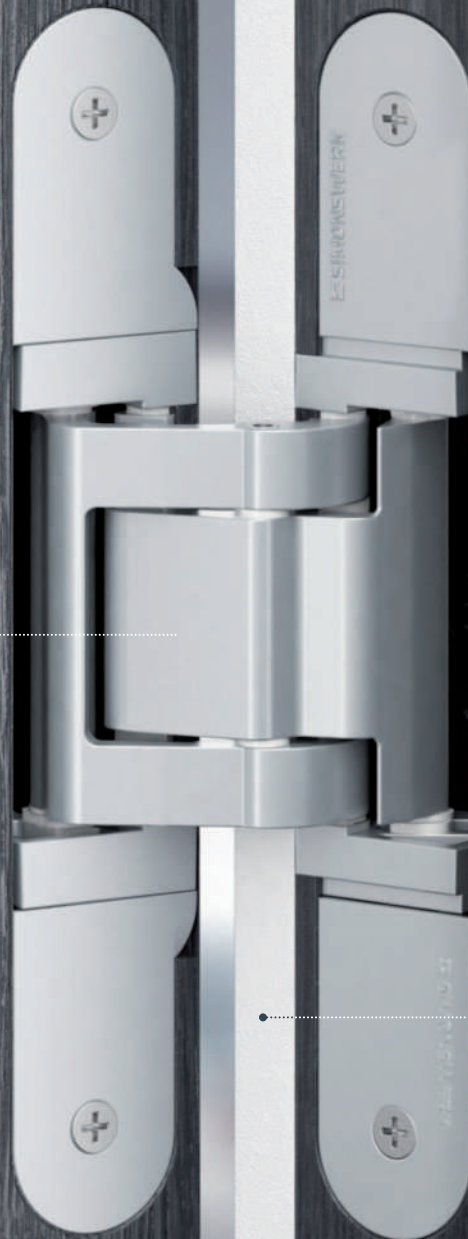

for 12 or 14 mm
recessed frame facings

for a surrounding wall
without a visible frame

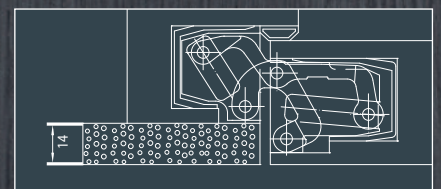

TECTUS®



e.g. TE 541 3D FVZ

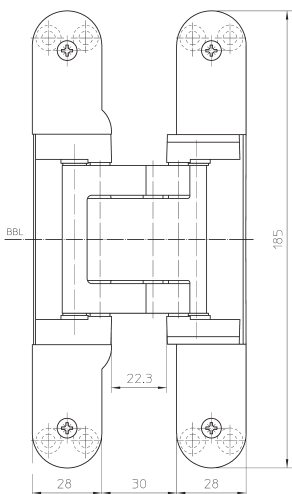

e.g. TE 541 3D FVZ

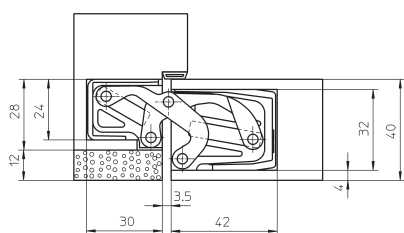

e.g. TE 311 3D FVZ 40

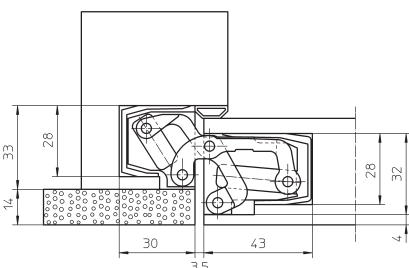

e.g. TE 541 3D FVZ

TECTUS FVZ

for unrebated residential and heavy-duty doors with recessed frame facings

hinge	recessed frame facings	60 – 100 kg
-------	------------------------	-------------

Product features

- FVZ = recessed frame facings
- recessed frame facing 12.0 or 14.0 mm
- completely concealed hinge system
- for timber, steel or aluminium frames
- for unrebated heavy-duty doors
- sideways closed hinge body for a homogeneous mortise appearance
- 3D adjustment (side +/- 3.0 mm, height +/- 3.0 mm, compression +/- 1.0 mm)
- maintenance-free slide bearings

Finishes

Satin Chrome Look (F1) (124), Satin Nickel Look (F2) (125), Stainless Steel Look (SSL) (126), coloured (079), other finishes available upon request

Combination

receiver	casing frame	TE ... FVZ FZ/1
	steel frame	TE ... FVZ SZ
	steel door	TE ... FVZ ST

Functional areas

fire resistance, smoke resistance, soundproof

Note

i The load capacity mentioned above refers to the use of two hinges per door leaf (1 x 2 m).

Classification key

4	7	5	1	1	*	0	12
---	---	---	---	---	---	---	----

*depending on the finish

Available options

load capacity up to 60 kg	door thickness 40 mm	TE 311 3D FVZ 40
	door thickness 44 mm	TE 311 3D FVZ 44
load capacity up to 100 kg		TE 541 3D FVZ

Detailed information in our PRODUCTSELECTOR at www.simonswerk.com

QUALITY MARKS



FUNCTIONAL AREAS



TECTUS® REBATED FOR REBATED RESIDENTIAL DOORS

SIMONSWERK also offers within the TECTUS brand a solution for rebated door leaves. The concealed hinge system is completely invisible when the door is closed. The hinge joint's special geometry allows for installation in the rebated door leaf with a receiver in the wood, steel or aluminium frame.



for rebated residential doors

load capacity up to 60 kg

TECTUS®

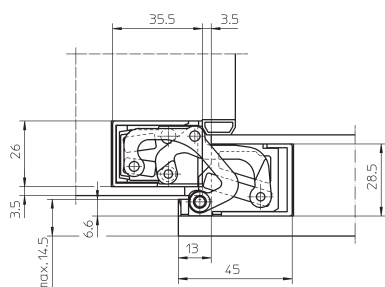
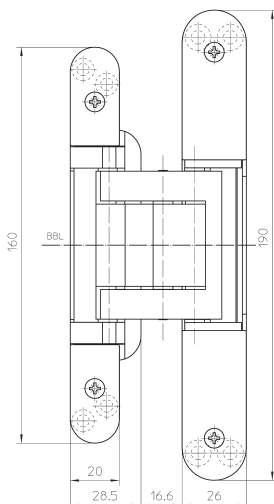

TE 380 3D

for rebated residential doors

hinge	rebated	up to 60 kg
-------	---------	-------------

Product features

- completely concealed hinge system
- for timber, steel or aluminium frames
- for rebated residential doors
- sideways closed hinge body for a homogeneous mortise appearance
- comfortable 3D adjustment (side +/- 3.0 mm, height +/- 3.0 mm, compression +/- 1.0 mm)
- maintenance-free slide bearings

Technical details

load capacity	i two hinges per door leaf (1x2m)	60.0 kg
width (frame part)		26.0 mm
width (door part)		20.0 mm
length (frame part)		190.0 mm
length (door part)		160.0 mm
cutter diameter		20.0 mm
opening angle		180°

Finishes

Satin Chrome Look (F1) (124), Satin Nickel Look (F2) (125), Stainless Steel Look (SSL) (126), Traffic White F (057), coloured (079), other finishes available upon request

Combination

receiver	casing frame	TE 380 3D FZ/1
	steel frame	TE 380 3D SZ

Installation tools

jig		universal milling frame
frame, step 1	template	No. 5 250955 5
frame, step 2	template	No. 5 250956 5
frame, step 3	template	No. 5 250957 5
door, step 1	template	No. 5 250958 5
door, step 2	template	No. 5 250959 5

Detailed information in our PRODUCTSELECTOR at www.simonswerk.com

Note

i The load capacity mentioned above refers to the use of two hinges per door leaf (1 x 2 m).

With an opening position of 180° the door may have to be fixed additionally.

Classification key

2	7	3	1	1	*	0	10
---	---	---	---	---	---	---	----

*depending on the finish

TECTUS® TE 680 3D FD

FOR REBATED ENTRANCE DOORS

With the new model version TECTUS TE 680 3D FD, SIMONSWERK offers a solution for conventional, rebated timber entrance doors. Easy mounting and comfortable 3D adjustment make installation easy, while a circumferential seal ensures the required level of impermeability around the hinges.



180 degrees opening angle

continuous
sealing system

load capacity up to 160 kg

comfortable
3D adjustment

TECTUS®



NEW

TE 680 3D FD

for rebated entrance doors

hinge	rebated	up to 160 kg
-------	---------	--------------

Product features

- concealed hinge system
- for rebated entrance doors
- sideways closed hinge body for a homogeneous mortise appearance
- comfortable 3D adjustment (side +/- 3.0 mm, height +/- 3.0 mm, compression +/- 1.5 mm)
- continuous sealing system
- 18 mm overlap width
- maintenance-free slide bearings

Technical details

load capacity	i two hinges per door leaf (1x2m)	160.0 kg
width (frame part)		30.0 mm
width (door part)		40,5 mm
length (frame part)		250.0 mm
length (door part)		140.0 mm
cutter diameter		20.0 mm
opening angle		180°

Finishes

Satin Chrome Look (F1) (124), other finishes available upon request

Combination

hinge	TE 680 3D FD Energy
accessories	gasket DS 7435

Installation tools

jig	routing jig TE 680 3D FD serial routing jig TE 680 3D FD
-----	---

Detailed information in our PRODUCTSELECTOR at www.simonswerk.com**Note**

i The load capacity mentioned above refers to the use of two hinges per door leaf (1 x 2 m).

With an opening position of 180° the door may have to be fixed additionally.

Available options

	TE 680 3D FD Energy
--	---------------------

Detailed information in our PRODUCTSELECTOR at www.simonswerk.com

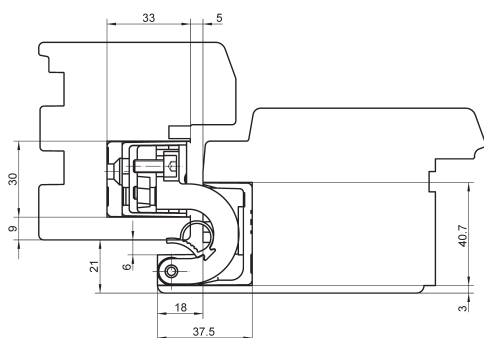
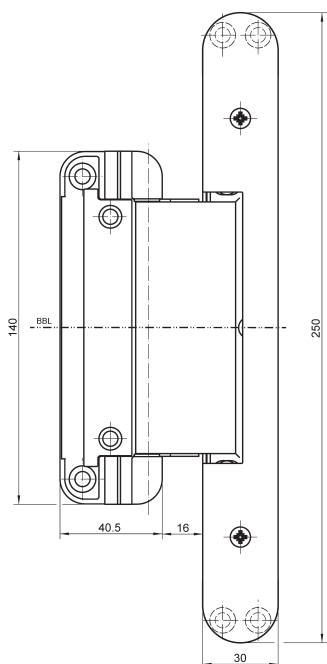

e.g. overlap width 21 mm

TECTUS® FR WITH INTEGRATED INTUMESCENT KIT

The TECTUS hinge system with integrated intumescent kit protects against fire and smoke escaping into a neighbouring room. In case of a fire, the intumescent kit swells, sealing the door around the hinges.

load capacity up to 200 kg

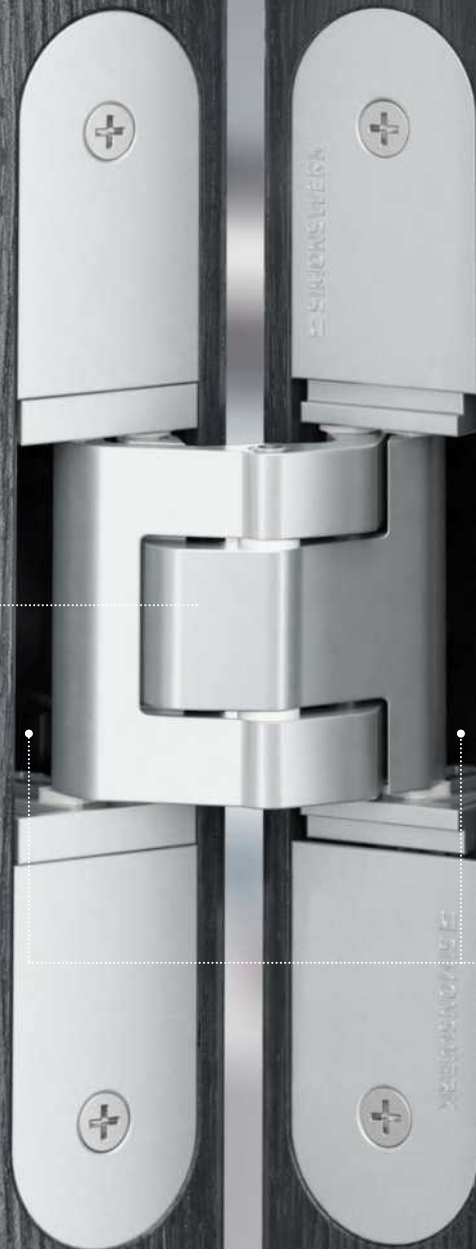

with integrated intumescent kit

The intumescent kit seals the hinge mortise in case of a fire.

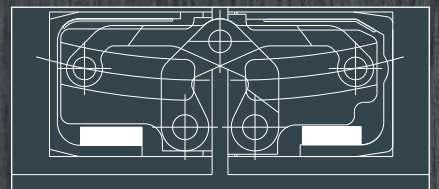



e.g. TE 540 3D FR

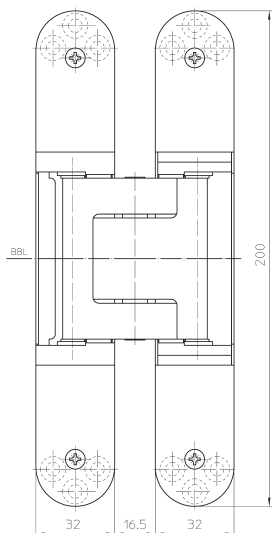

e.g. TE 540 3D FR

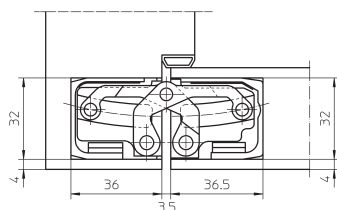

e.g. TE 540 3D FR

TECTUS FR

with integrated intumescent kit for unrebated heavy-duty doors

hinge	fire resistance	80 – 200 kg
-------	-----------------	-------------

Product features

- with integrated intumescent kit
- completely concealed hinge system
- for timber, steel or aluminium frames
- for unrebated heavy-duty doors
- sideways closed hinge body for a homogeneous mortise appearance
- comfortable 3D adjustment (side +/- 3.0 mm, height +/- 3.0 mm, compression +/- 1.0 mm)
- maintenance-free slide bearings

Finishes

Satin Chrome Look (F1) (124), Stainless Steel Look (SSL) (126), other finishes available upon request

Combination

receiver	casing frame	TE ... 3D FZ/1
	steel frame	TE ... 3D SZ
	steel door	TE ... 3D ST

Functional areas

fire resistance, smoke resistance, soundproof, burglar resistance

Note

i The load capacity mentioned above refers to the use of two hinges per door leaf (1 x 2 m).

Classification key (e.g.)

4	7	6	1	1	*	1	13
---	---	---	---	---	---	---	----

*depending on the finish

Available options

load capacity up to 80 kg	TE 340 3D FR
load capacity up to 120 kg	TE 540 3D FR
load capacity up to 200 kg	TE 640 3D FR
load capacity up to 100 kg	TE 540 3D A8 FR
load capacity up to 160 kg	TE 640 3D A8 FR

Detailed information in our PRODUCTSELECTOR at www.simonswerk.com

TECTUS®

TE 640 3D BW

fixing angle for unrebutted heavy-duty doors with claddings up to 16 resp. 20 mm on both sides

receiver		block frame
----------	--	-------------

Technical details

load capacity	i two hinges per door leaf (1x2m)	120.0 kg
---------------	--	----------

Finishes

blue galvanized (010)

Combination

hinge	TE 640 3D
-------	-----------

Note

i The load capacity mentioned above refers to the use of two hinges per door leaf (1 x 2 m).

The cladding must be mortised in the hinge area.

Please specify the exact version in your order.

Available options

claddings up to 16 mm	TE 640 3D BW 16
-----------------------	-----------------

claddings up to 20 mm	TE 640 3D BW 20
-----------------------	-----------------

Detailed information in our PRODUCTSELECTOR at www.simonswerk.com



NEW

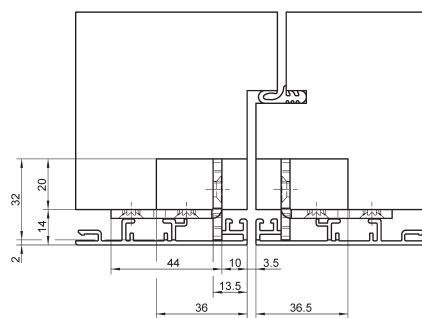

timber/aluminium system

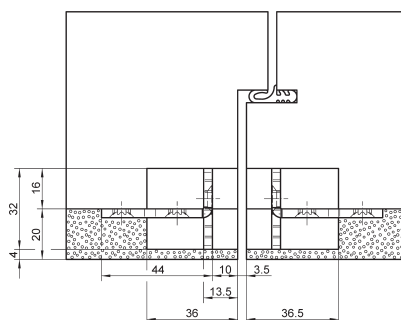

claddings up to 20 mm

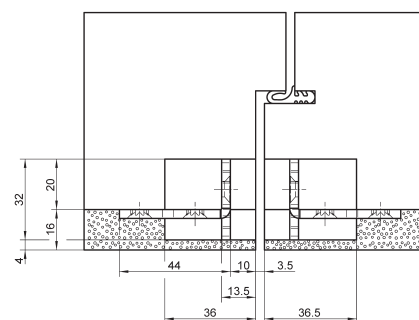

claddings up to 16 mm

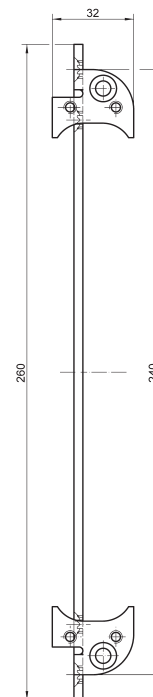

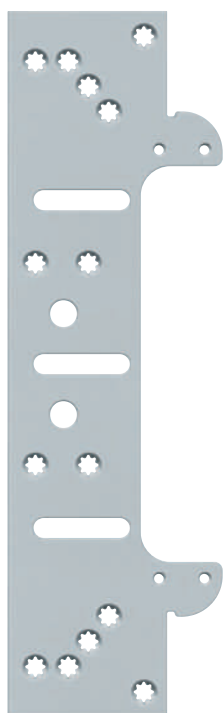

Fixing plate TE ... 3D FZ

for residential and heavy-duty doors with casing frames

receiver	casing frame
----------	--------------

Finishes
blue galvanized (010)

Combination	
hinge	TE 240 3D
	TE 311 3D FVZ
	TE 340 3D
	TE 380 3D
	TE 526 3D
	TE 527 3D
	TE 540 3D
	TE 541 3D FVZ
	TE 640 3D
	TE 540 3D A8
	TE 626 3D A8
	TE 640 3D A8
with energy transfer	TE 240 3D Energy
	TE 340 3D Energy
	TE 526 3D Energy
	TE 540 3D Energy
	TE 640 3D Energy
	TE 540 3D A8 Energy
with intumescent kit	TE 640 3D A8 Energy
	TE 340 3D FR
	TE 540 3D FR
	TE 640 3D FR
	TE 540 3D A8 FR
	TE 640 3D A8 FR

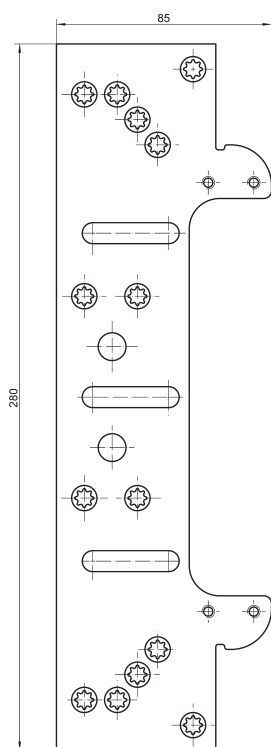

e.g. TE 540 3D FZ/1

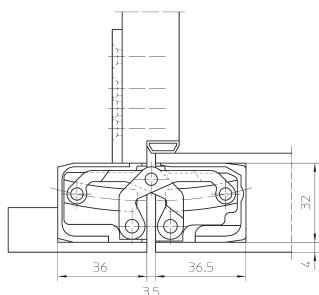

e.g. TE 540 3D with TE 540 3D FZ/1

Note
Spacers for casing thicknesses of 22-28 mm are included.
Please specify the exact hinge in your order.

TECTUS®

Receiver TE ... 3D SZ

for residential and heavy-duty doors with steel frames

receiver	steel frame
----------	-------------

Finishes

blue galvanized (010), Stainless Steel untreated (041)

Combination

hinge	TE 240 3D
	TE 311 3D FVZ
	TE 340 3D
	TE 380 3D
	TE 526 3D
	TE 527 3D
	TE 540 3D
	TE 541 3D FVZ
	TE 640 3D
	TE 645 3D
	TE 540 3D A8
	TE 626 3D A8
	TE 640 3D A8
with energy transfer	TE 240 3D Energy
	TE 340 3D Energy
	TE 526 3D Energy
	TE 540 3D Energy
	TE 640 3D Energy
	TE 645 3D Energy
	TE 540 3D A8 Energy
	TE 626 3D A8 Energy
	TE 640 3D A8 Energy
with intumescent kit	TE 340 3D FR
	TE 540 3D FR
	TE 640 3D FR
	TE 540 3D A8 FR
	TE 640 3D A8 FR

Note

Please specify the exact hinge in your order.

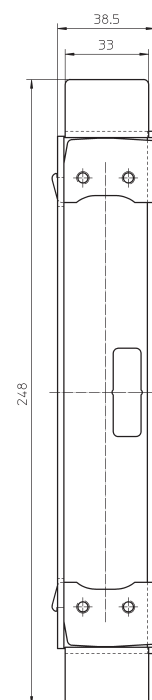

e.g. TE 540 3D SZ

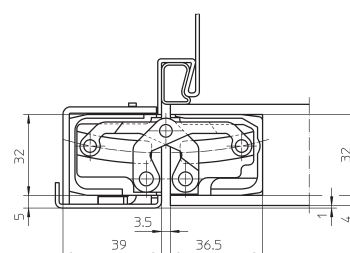

e.g. TE 540 3D with TE 540 3D SZ/1



Receiver TE ... 3D ST

for steel doors

receiver		steel door
----------	--	------------

Finishes
blue galvanized (010)

Combination	
hinge	TE 240 3D TE 340 3D TE 526 3D TE 527 3D TE 540 3D TE 541 3D FVZ TE 640 3D TE 645 3D TE 540 3D A8 TE 640 3D A8
with energy transfer	TE 240 3D Energy TE 340 3D Energy TE 526 3D Energy TE 540 3D Energy TE 640 3D Energy TE 540 3D A8 Energy TE 640 3D A8 Energy
with intumescent kit	TE 340 3D FR TE 540 3D FR TE 640 3D FR TE 540 3D A8 FR TE 640 3D A8 FR

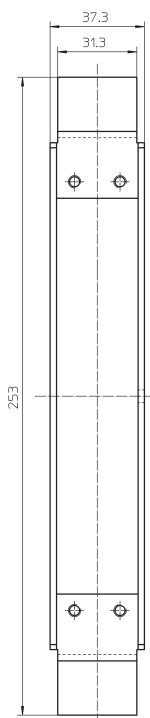

e.g. TE 540 3D ST

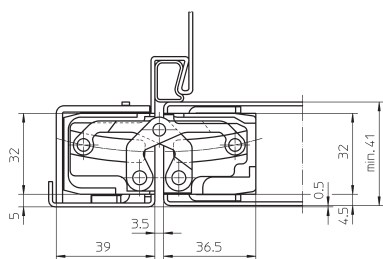

e.g. TE 540 3D with TE 540 3D ST

Note
Please specify the exact hinge in your order.

ASSEMBLY

TECTUS series

DOOR

Fix door part with enclosed wood screws.

FRAME

Block frame

Conduct routing, cutter 24 mm Ø (TE 240 3D cutter 16 mm Ø) and collar ring 30 mm Ø, affix frame part with enclosed wood screws.

Casing frame

To guarantee a stable mounting the use of an additional fixing plate is required. Affix the fixing plate behind the casing. Affix the hinge by using enclosed M5 screws.

Steel frame

Affix frame part of the hinge with the prepared receiver inside the door frame by using the enclosed M5 screws.

Fix cover plates on the frame and door part by means of the enclosed screws.

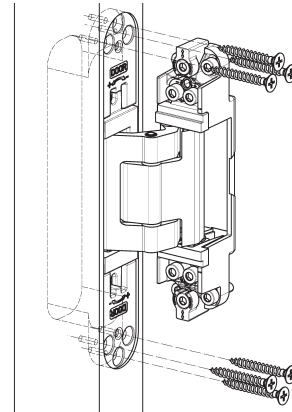

e.g. TE 540 3D

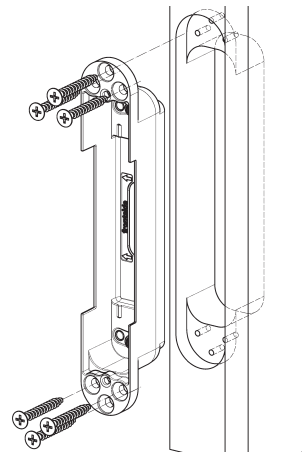

e.g. TE 540 3D

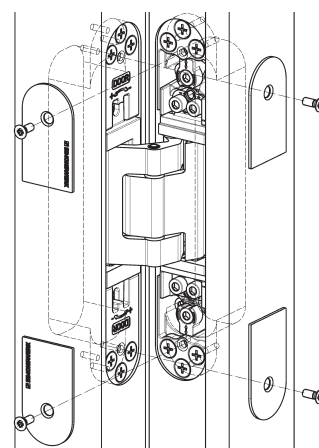

e.g. TE 540 3D

ADJUSTMENT

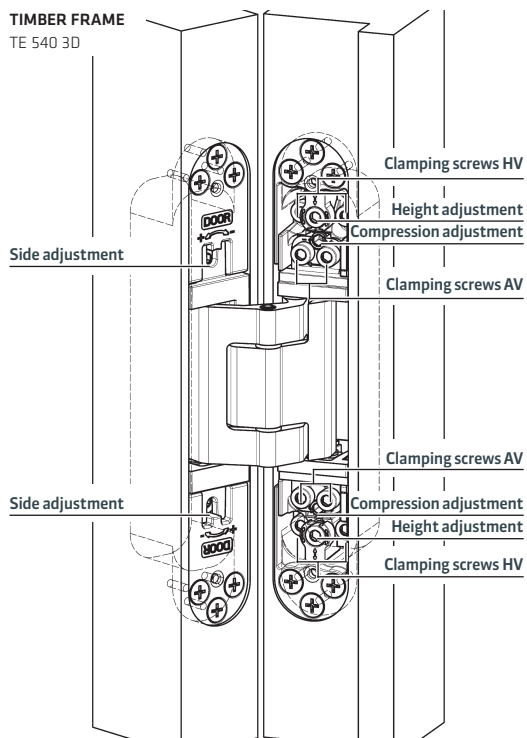

TECTUS series

Three-dimensionally, continuously adjustable

side	+/- 3.0 mm
height	+/- 3.0 mm
compression	+/- 1.0 mm

Side adjustment

- adjust the adjusting spindles using an Allen wrench

Height adjustment

- slightly loosen the clamping screws
- adjust the vertical position of the door by turning the lower height adjustment screw (turn the upper height adjustment screw in the opposite direction if necessary)
- retighten the clamping screws

Compression adjustment

- slightly loosen the fixing screws
- put the door to the correct compression by using the compression screw
- retighten the clamping screws

All adjustments to be conducted by means of a 4 mm Allen wrench.

HINGE POSITIONS

TECTUS Series

The use of a third hinge can significantly influence the load capacity. Frequently, a third hinge is positioned centred between the two outer hinges in order to meet visual requirements and to ensure the sealing pressure in the middle of the door. Under certain circumstances, however, it may be useful or necessary to support the upper hinge where the main tensile forces occur. This could be the case for over-wide doors (> 1000 mm) where additional forces occur due to the leverage. In such cases, the third hinge has to be positioned in the upper third, as this is the only way to positively influence the load capacity. The door norm recommends the use of a third hinge 350 mm below the upper hinge.

Application with increased load capacity or overhead door closers

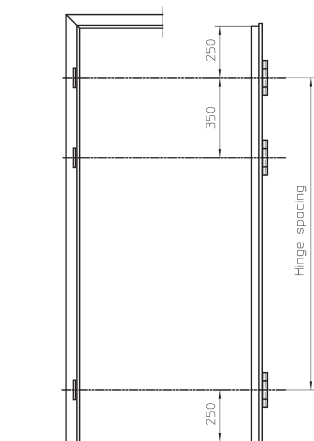

Examples for applications with different door heights

< 2.40 m

≥ 2.40 m

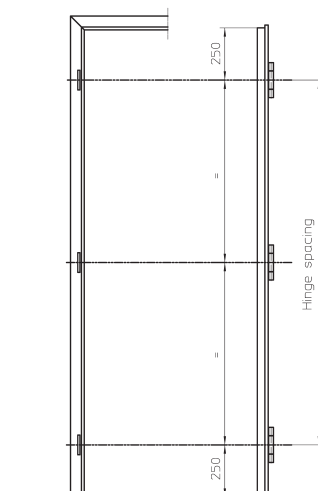
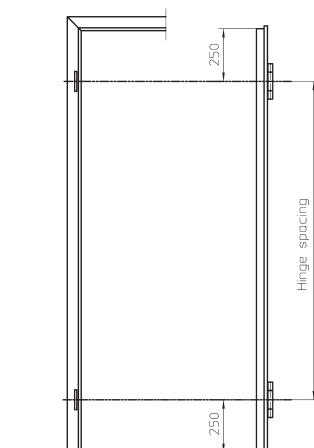

Note: We recommend for all exterior doors the use of three hinges.

TECTUS® - FINISHES



polished brass (030)



polished nickelled (038)



Satin Stainless Steel (040)



satin brass (047)



RAL 9016 Traffic White (070)



RAL 9005 Matte Deep Black (107)



Satin Chrome Look (124)



Satin Nickel Look (125)



Stainless Steel Look (126)



Satin Nickel (144)



Satin Chrome (146)



Rustic UMBER (156)



Bronze Metallic (168)



Bronze Finish (174)



Bronze Finish Light (175)



Bronze Finish Dark (176)

The colours of the finishes shown may differ from the original.

ROUTING DATA

TE 240 3D

Conduct routing with cutter Ø 16 mm, collar ring Ø 30 mm and universal milling frame with template No. 5 250691 6 (frame) and template No. 5 250692 6 (door).

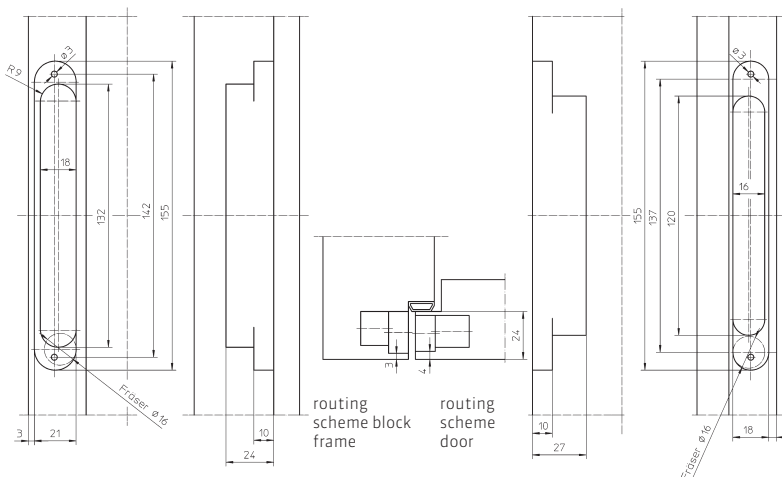

TE 340 3D / TE 340 3D FR

A = depth of frame rebate up to sealing
 B = thickness of door leaf resp. 1st door rebate
 $A - B + 4 = \text{Measure X}$

The result has to be a measure between 4.0 mm and max. 6.0 mm. (steel frame: X = 5.0 mm)

Conduct routing with cutter Ø 24 mm, collar ring Ø 30 mm and universal milling frame with template No. 5 250693 5 (Step 1) and template No. 5 250694 5 (Step 2).

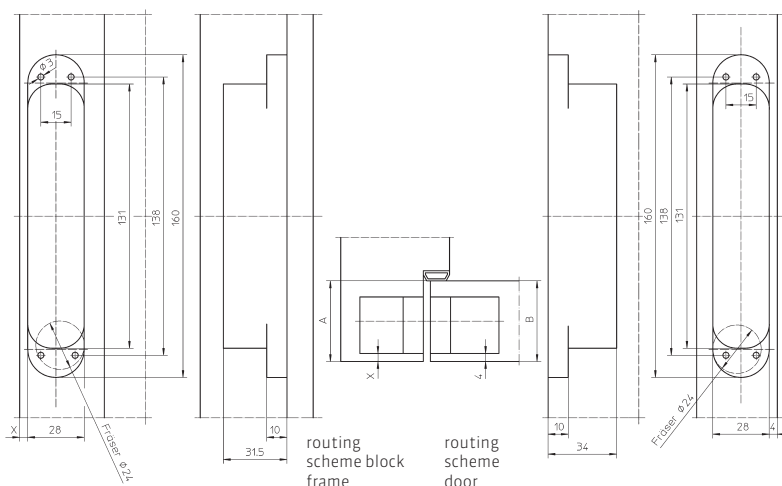

ROUTING DATA

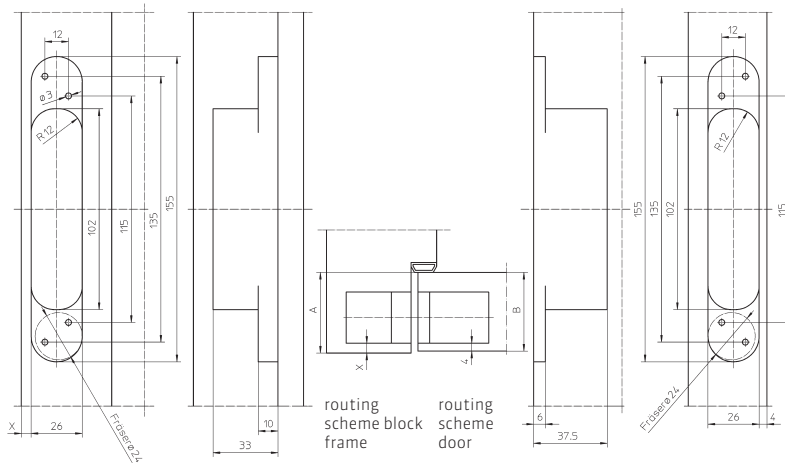

TE 526 3D / TE 527 3D

A = depth of frame rebate up to sealing
 B = thickness of door leaf resp. 1st door rebate
 $A - B + 4 = \text{Measure X}$

The result has to be a measure between 4.0 mm and max. 6.0 mm. (steel frame: X = 5.0 mm)

Conduct routing with cutter Ø 24 mm, collar ring Ø 30 mm and universal milling frame with template No. 5 250547 6.

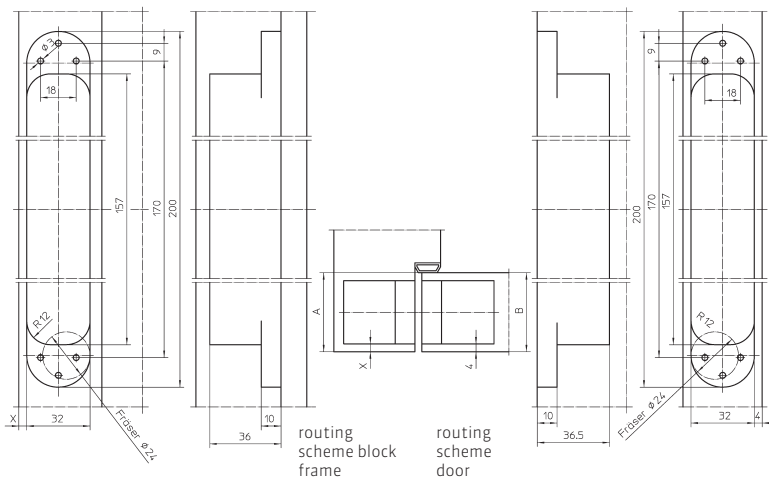

TE 540 3D / TE 540 3D FR

A = depth of frame rebate up to sealing
 B = thickness of door leaf resp. 1st door rebate
 $A - B + 4 = \text{Measure X}$

The result has to be a measure between 4.0 mm and max. 6.0 mm. (steel frame: X = 5.0 mm)

Conduct routing with cutter Ø 24 mm, collar ring Ø 30 mm and universal milling frame with template No. 5 250680 5 (Step 1) and template No. 5 250681 5 (Step 2).

ROUTING DATA

TE 640 3D / TE 640 3D FR

A = depth of frame rebate up to sealing
 B = thickness of door leaf resp. 1st door rebate
 A - B + 4 = Measure X

The result has to be a measure between 4.0 mm and max. 6.0 mm. (steel frame: X = 5.0 mm)

Conduct routing with cutter Ø 24 mm, collar ring Ø 30 mm and universal milling frame with template No. 5 250659 5 (Step 1) and template No. 5 250689 5 (Step 2).

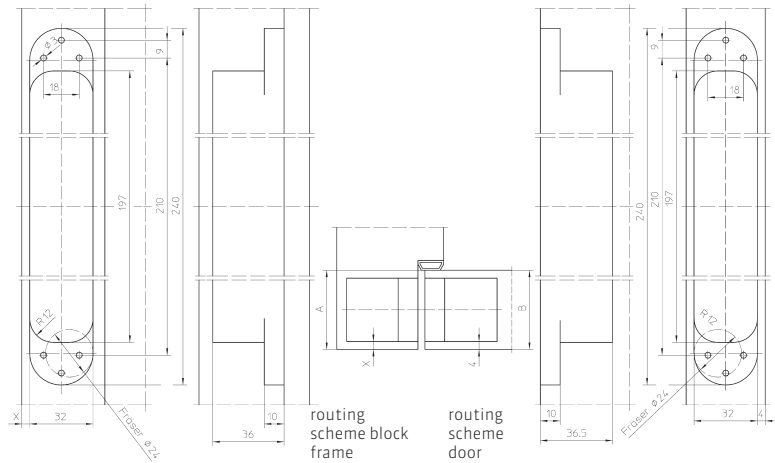

TE 645 3D

A = depth of frame rebate up to sealing
 B = thickness of door leaf resp. 1st door rebate
 A - B + 4 = Measure X

The result has to be a measure between 4.0 mm and max. 6.0 mm. (steel frame: X = 5.0 mm)

Conduct routing with cutter Ø 24 mm, collar ring Ø 30 mm and universal milling frame with template No. 5 250945 5 (frame, step 1), template No. 5 250946 5 (frame, Step 2), template No. 5 250947 5 (door, step 1) and template No. 5 250948 5 (door, step 2).

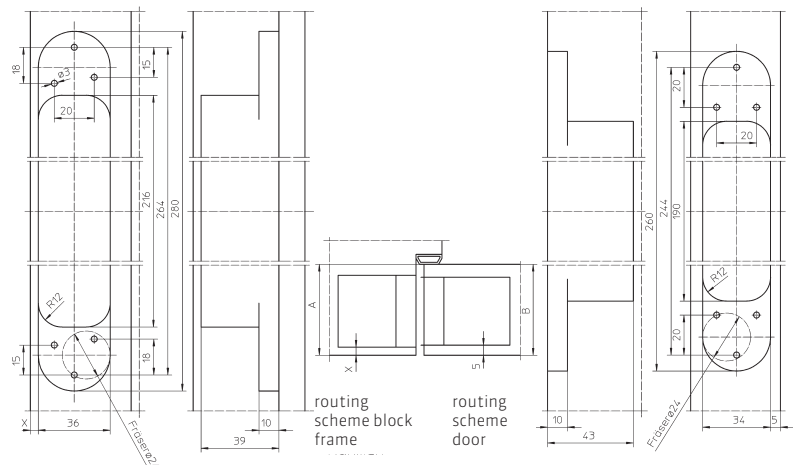

ROUTING DATA

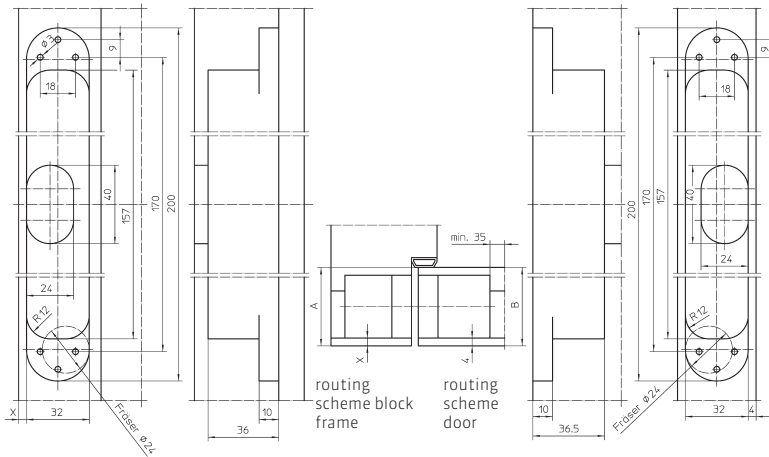

TE 540 3D Energy

(exemplary illustration)

A = depth of frame rebate up to sealing
 B = thickness of door leaf resp. 1st door rebate
 $A - B + 4$ = Measure X

The result has to be a measure between 4.0 mm and max. 6.0 mm. (steel frame: X = 5.0 mm)

Conduct routing with cutter \varnothing 24 mm, collar ring \varnothing 30 mm and universal milling frame with template No. 5 250680 5 (step 1), template No. 5 250681 5 (step 2) and template No. 5 250939 5 (additional routing Energy).

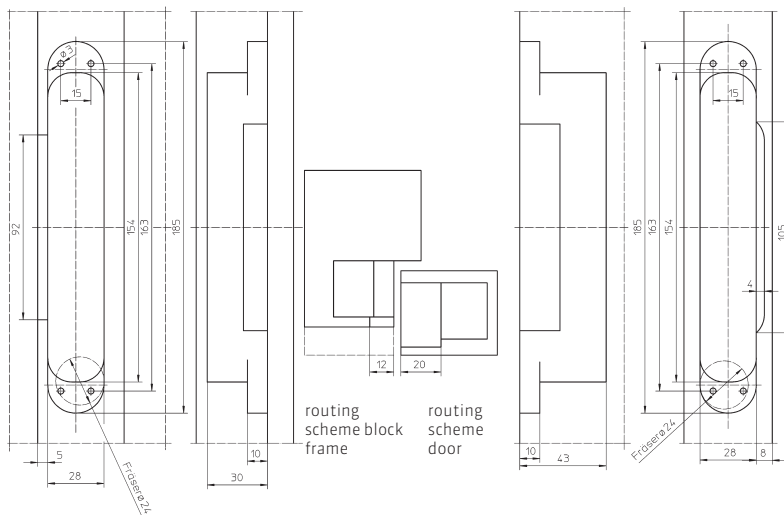

TE 541 3D FVZ

Conduct routing with cutter \varnothing 24 mm, collar ring \varnothing 30 mm and universal milling frame with template No. 5 250942 5 (frame, step 1), template No. 5 250943 5 (frame, step 2), template No. 5 250682 5 (frame, step 3), template No. 5 250942 5 (door, step 1), template No. 5 250943 5 (door, step 2) and template No. 5 250944 5 (door, Step 3).

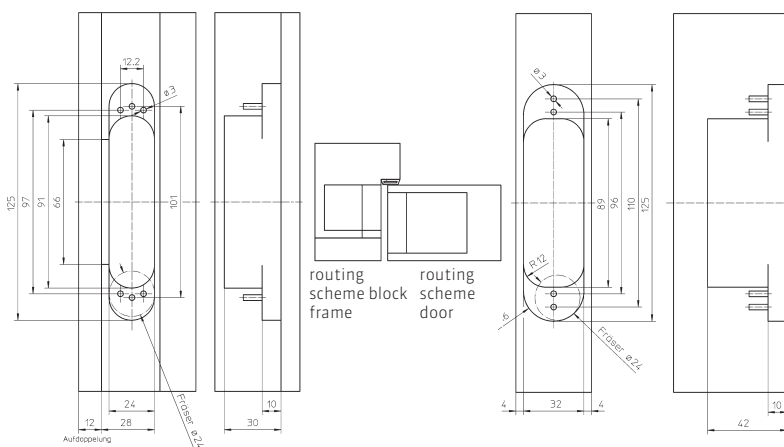

TE 311 FVZ

Conduct routing with cutter \varnothing 24 mm, collar ring \varnothing 30 mm and universal milling frame with template No. 5 251100 6, template No. 5 251101 6 (door, door thickness 40 mm) and template No. 5 251102 6 (door, door thickness 44 mm).

ROUTING DATA

TE 540 3D A8 / TE 540 3D A8 FR

Conduct routing with cutter \varnothing 24 mm, collar ring \varnothing 30 mm and universal milling frame with template No. 5 250680 5 (Step 1), template No. 5 250681 5 (Step 2) and template No. 5 250682 5 (Step 3).

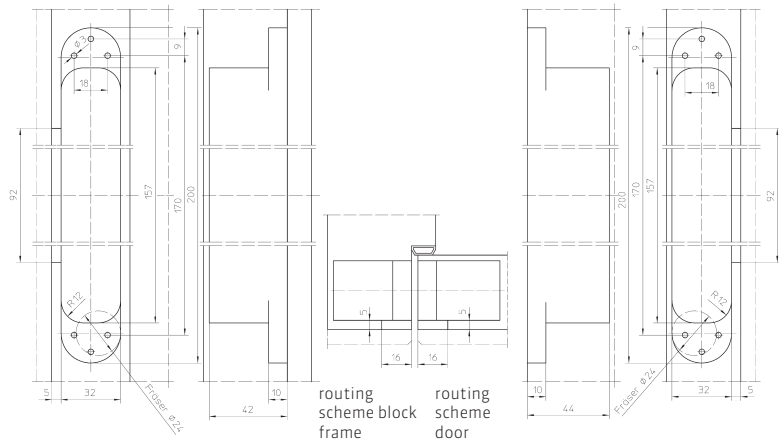

TE 626 3D A8

Conduct routing with cutter \varnothing 24 mm, collar ring \varnothing 30 mm and universal milling frame with template No. 5 250659 5 (Step 1), template No. 5 250689 5 (Step 2) and template No. 5 250690 5 (Step 3).

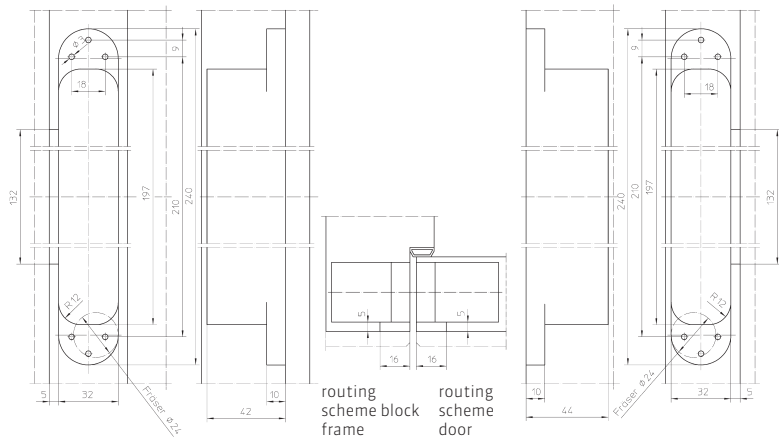

ROUTING DATA

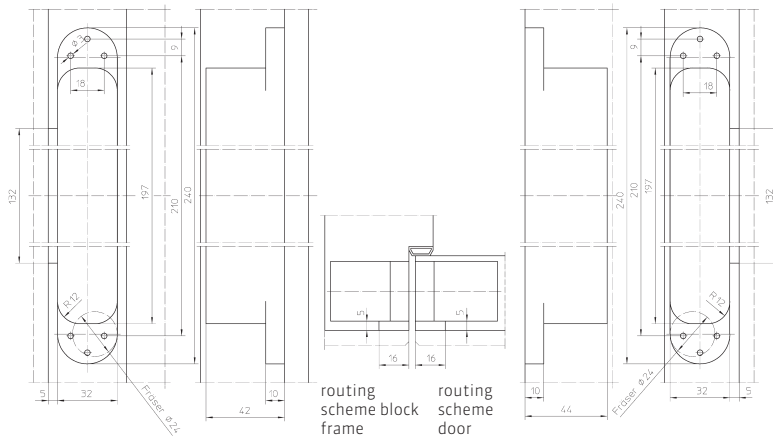

TE 640 3D A8 / TE 640 3D A8 FR

Conduct routing with cutter $\varnothing 24$ mm, collar ring $\varnothing 30$ mm and universal milling frame with template No. 5 250659 5 (Step 1), template No. 5 250689 5 (Step 2) and template No. 5 250690 5 (Step 3).

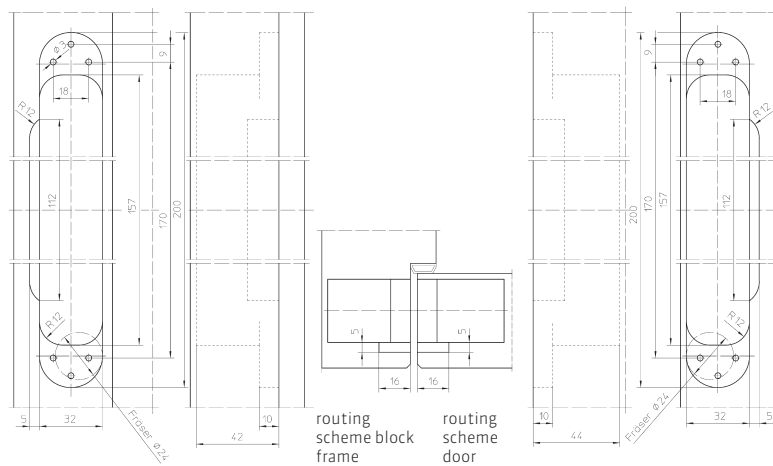

TE 540 3D A8 (without cladding)

Conduct routing with cutter $\varnothing 24$ mm, collar ring $\varnothing 30$ mm and universal milling frame with template No. 5 250680 5 (Step 1), template No. 5 250681 5 (Step 2) and template No. 5 250687 5 (Step 3).

ROUTING DATA

TE 626 3D A8 (without cladding)

Conduct routing with cutter \varnothing 24 mm, collar ring \varnothing 30 mm and universal milling frame with template No. 5 250659 5 (Step 1), template No. 5 250689 5 (Step 2) and template No. 5 250688 5 (Step 3).

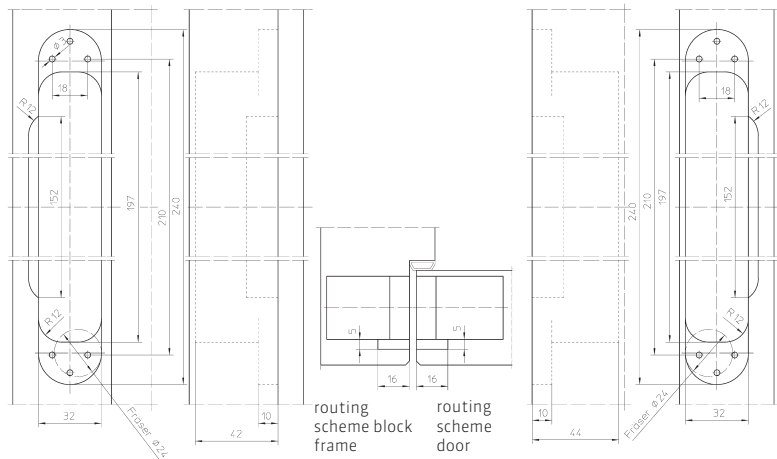

TE 640 3D A8 (without cladding)

Conduct routing with cutter \varnothing 24 mm, collar ring \varnothing 30 mm and universal milling frame with template No. 5 250659 5 (Step 1), template No. 5 250689 5 (Step 2) and template No. 5 250688 5 (Step 3).

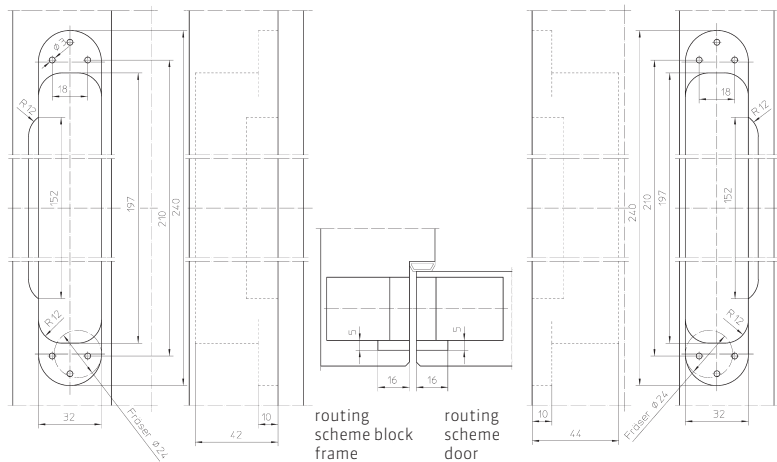

ROUTING DATA

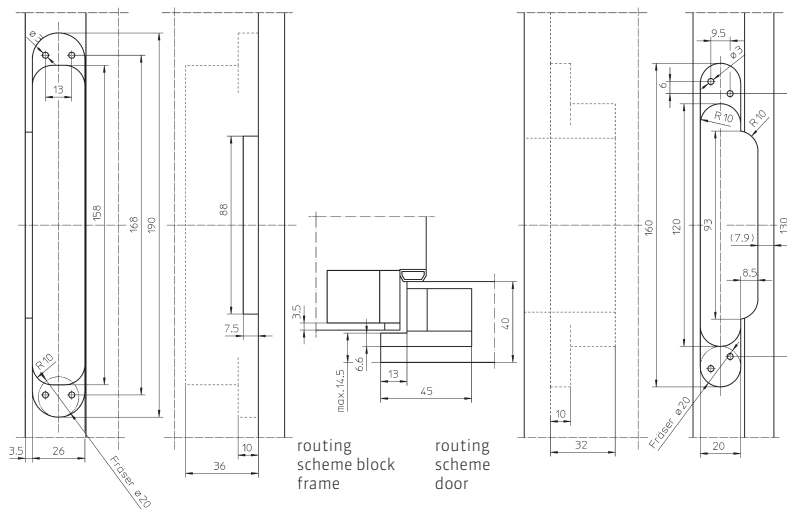

TE 380 3D

Conduct routing with cutter Ø 20 mm, collar ring Ø 30 mm and universal milling frame with template No. 5 250955 5 (frame, step 1), template No. 5 250956 5 (frame, step 2), template No. 5 250957 5 (frame, step 3), template No. 5 250958 5 (door, step 1) and template No. 5 250959 5 (door, step 2).

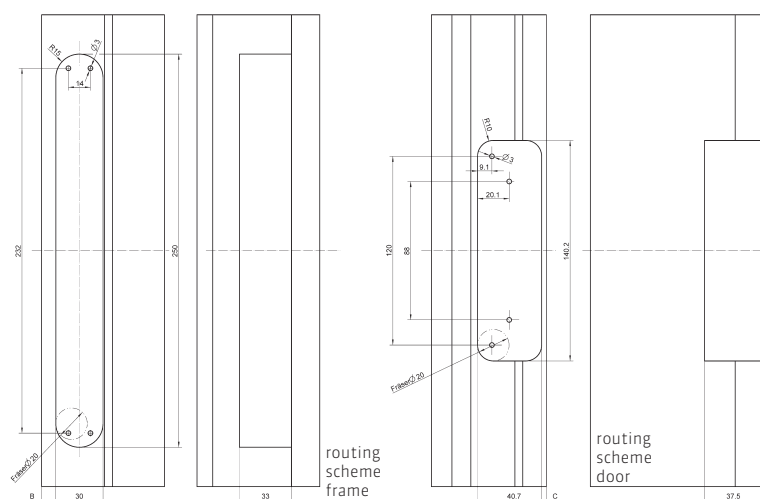

TE 680 3D FD

Conduct routing with cutter Ø 20 mm, collar ring Ø 30 mm.

Overlap thickness		Template No.
21.0 mm	frame	5 251112 5
22.0 mm	frame	5 251113 5
23.0 mm	frame	5 251113 5
24.0 mm	frame	5 251113 5
25.0 mm	frame	5 251113 5
26.0 mm	frame	5 251114 5
27.0 mm	frame	5 251114 5
21.0 mm	door	5 251109 5
22.0 mm	door	5 251109 5
23.0 mm	door	5 251110 5
24.0 mm	door	5 251110 5
25.0 mm	door	5 251111 5
26.0 mm	door	5 251111 5
27.0 mm	door	5 251111 5

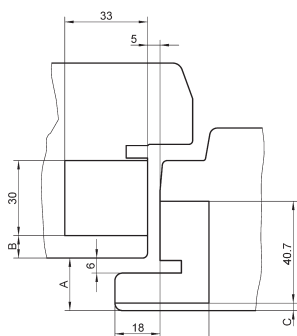

	A	B	C
Overlap thickness	RT	FT	
21	9	3	
22	8	3	
23	8	4	
24	7	4	
25	7	5	
26	6	5	
27	5	5	

SIMONSWERK – THE ORIGINAL HINGE SYSTEMS

SIMONSWERK is a leading manufacturer of heavy-duty, high performance hinge systems, producing premium hinges for over 125 years. As an industry pioneer for adjustable concealed door hinge systems, SIMONSWERK has built an impressive and extensive product offering including a wide range of architectural finishes for high-traffic and heavy-use doors.

With a hinge system for nearly every application, SIMONSWERK constantly strives to meet the demand for innovative design solutions, utilizing functional tools to ensure a simple and smooth installation process. In addition, SIMONSWERK makes every effort to offer an outstanding customer service experience.



QUALITY AND INNOVATION

The SIMONSWERK brand stands for innovation and high standards of quality and service. These cornerstones date back as far as 1889, with customized solutions leading to the development of new products every year.

SIMONSWERK's quality requirements begin with the products, specifically in the selection of raw materials. Using high-quality materials allows for the largest possible freedom of design, providing diverse options for surface refinement and protection against corrosion.

State-of-the-art resources, including the latest manufacturing techniques and highly flexible automated production processes, make SIMONSWERK a competent partner for all aspects of door hinge technology. To meet the technical, safety and design requirements of modern architecture, SIMONSWERK hinge systems feature precise functioning, often exceeding demands and expectations.

A company's innovative strength is expressed through its competence and its responsibility to its customers in the marketplace. Longevity, top-quality products, and creative thinking give SIMONSWERK the ability to open new markets with new ideas.



SERVICE – COMPREHENSIVE EXPERTISE FOR YOUR DAILY WORK

We are happy to provide you with all the documentation you need to calculate which is the most suitable hinge system for your requirements. Please contact us: we would be delighted to work with you to choose the best solution – from high-quality standard sets right up to the most complex solutions.

Please visit our home page for any information not included in this brochure. You will find it easy to navigate through our user-friendly website to arrive at the detailed, comprehensive solutions.

All our brochures and data sheets can be requested in a printed version, or you can simply download them on the spot – and the same applies to our fitting instructions and milling data.

www.simonswerk.com



VISIT OUR PRODUCTSELECTOR

Whether you are a manufacturer, trade partner or designer, at www.simonswerk.com you can find precise, detailed product descriptions that will help you to choose the most suitable hinge systems.

CONTAINS

TE 240 3D	TECTUS® A8
TE 340 3D	TECTUS® Energy
TE 526 3D	TECTUS® FVZ
TE 527 3D	TECTUS® rebated
TE 540 3D	TECTUS® entrance door
TE 640 3D	TECTUS® FR
TE 645 3D	

PLEASE VISIT THE PRODUCTSELECTOR AT
www.simonswerk.com

SIMONSWERK GmbH

Bosfelder Weg 5
33378 Rheda-Wiedenbrück
Germany

Fon +49 (0)5242/413-0
Fax +49 (0)5242/413-260

sales@simonswerk.de
www.simonswerk.com

