



Attractive finish –  
HOPPE handles in black matt

For all HOPPE door and window handles ...





Interior door sets

page 5

---



Handle sets on mini rose

page 11

---



Window handles and lift/slide  
handle sets

page 15

---



Pull handles

page 29

---



General information

page 34

---

AI

## Highly fashionable: aluminium architectural fittings in black matt

There is a good reason why black is such a popular colour for door and window handles – depending on how they are combined, they can create very different effects in living spaces: elegant and unobtrusive or high-contrast and vibrant.

Lovers of black will find a large selection of different door fittings and window handles at HOPPE, such as aluminium architectural fittings in black matt, which are available from us in the colour designation F9714M.

Many of HOPPE's most popular series such as Dallas, Tôkyô and Toulon are available in F9714M – in many cases both as a door handle set and as window handles, available with or without burglary-resistant technology.

The HOPPE architectural fittings in black matt are manufactured from aluminium, an ideal material for door and window handles. The natural corrosion protection that forms when the material is processed makes aluminium architectural fittings extraordinarily resistant to environmental influences and mechanical damages. Furthermore, aluminium handles have no adverse effects on health whatsoever and can be fully recycled without loss of quality. Aluminium architectural fittings do not require special care – any dirt can be removed quite simply using a damp cloth.

Like all HOPPE products, handles in the colour F9714M are made in Europe and are covered by a ten-year guarantee on mechanical operation. After all, HOPPE architectural fittings are brand products – which HOPPE considers a promise of quality.





## Hamburg - 1700/42FI/42FIS

duraplus®



Quick-Fit

HOPPE aluminium handle set on rose with escutcheons for interior doors:

- Bearing: loose door handles, non-handed spring cassettes, maintenance-free slide bearing
- Connection: **HOPPE Quick-Fit connection** with HOPPE solid spindle (spindle - receiver components)
- Base: nylon
- Fixing: concealed, bolt-through, bidirectional, multi-purpose screws

Description			Keyhole	F9714M			P.U.	O.C.
				Art. no./€				
Door handle set	37-42	8		<b>11782754</b>			1	10
Bathroom/WC handle set with red-white-indicator	37-42	8 5 diag.		11783060			1	10

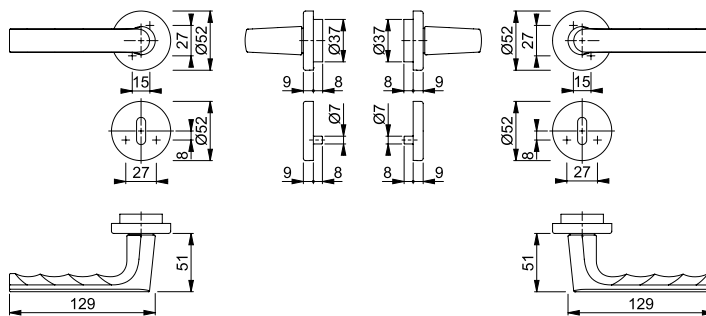

## New York - 1810/42FI/42FIS

duraplus®



Quick-Fit

HOPPE aluminium handle set on rose with escutcheons for interior doors:

- Bearing: loose door handles, non-handed spring cassettes, maintenance-free slide bearing
- Connection: **HOPPE Quick-Fit connection** with HOPPE solid spindle (spindle - receiver components)
- Base: nylon
- Fixing: concealed, bolt-through, bidirectional, multi-purpose screws

Description			Keyhole	F9714M			P.U.	O.C.
				Art. no./€				
Door handle set	37-42	8		<b>11962227</b>			1	10
Bathroom/WC handle set with red-white-indicator	37-42	8 5 diag.		11962239			1	10

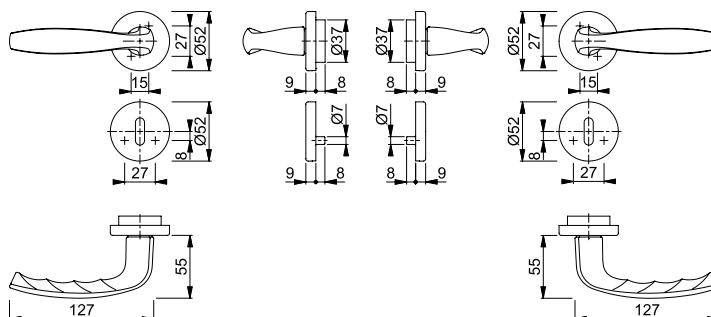



Quick-Fit

### Stockholm - 1140/42FI/42FIS

duraplus®

HOPPE aluminium handle set on rose with escutcheons for interior doors:

- Bearing: loose door handles, non-handed spring cassettes, maintenance-free slide bearing
- Connection: **HOPPE Quick-Fit connection** with HOPPE solid spindle (receiver - receiver components)
- Base: nylon, supporting lugs
- Fixing: concealed, bolt-through, bidirectional, multi-purpose screws

Description			Keyhole	F9714M			P.U.	O.C.
				Art. no./€				
Door handle set (receiver - receiver components)	37-42	8		<b>11746828</b> <b>25.64</b>			1	10
Bathroom/WC handle set with red-white-indicator	37-42	8 5 diag.		11891105 <b>32.99</b>			1	10

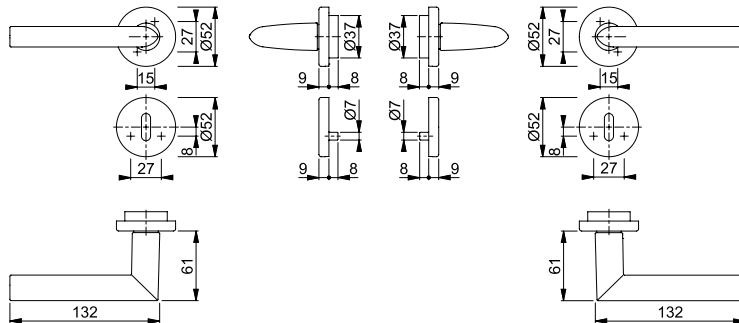

Quick-Fit

### Tôkyô - 1710/42FI/42FIS

duraplus®

HOPPE aluminium handle set on rose with escutcheons for interior doors:

- Bearing: loose door handles, non-handed spring cassettes, maintenance-free slide bearing
- Connection: **HOPPE Quick-Fit connection** with HOPPE solid spindle (receiver - receiver components)
- Base: nylon, supporting lugs
- Fixing: concealed, bolt-through, bidirectional, multi-purpose screws

Description			Keyhole	F9714M			P.U.	O.C.
				Art. no./€				
Door handle set (receiver - receiver components)	37-42	8		<b>11747055</b> <b>19.53</b>			1	10

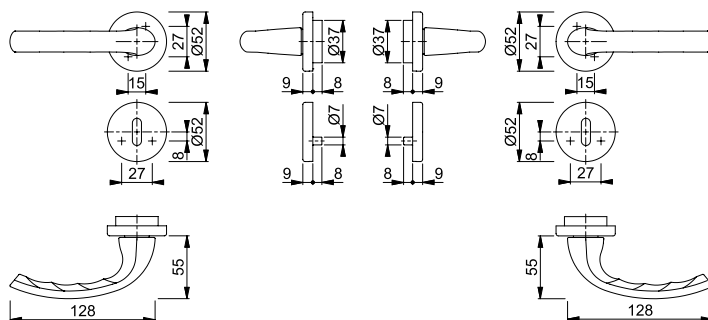



Quick-Fit



## ■ Tôkyô - 1710/42K/42KS

duraplus®

HOPPE aluminium handle set on rose with escutcheons for interior doors:

- Tested to **DIN EN 1906: 37-0140A**, handle set for commercial applications
- Bearing: loose door handles, non-handed spring cassettes, maintenance-free slide bearing
- Connection: **HOPPE Quick-Fit connection** with HOPPE solid spindle (receiver - receiver components)
- Base: nylon
- Fixing: concealed, multi-purpose screws



Description			Keyhole	F9714M				P.U.	O.C.
				Art. no./€					
Door handle set (receiver - receiver components)	75-85	8		<b>11747717</b> <b>18.10</b>				1	10

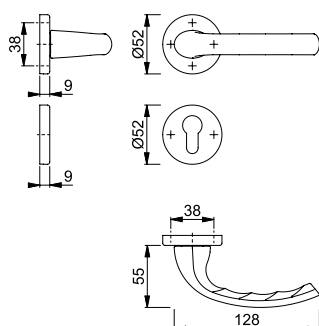

For DIN-standard-locks.





## ■ 42FIS

duraplus®

HOPPE aluminium escutcheon pair with emergency release/turn and red-white-indicator for bathroom/WC doors:

- Base: nylon
- Fixing: concealed, bolt-through, bidirectional, multi-purpose screws

Description			Keyhole	F9714M				P.U.	O.C.
				Art. no./€					
Bathroom/WC escutcheon with red-white-indicator, offset by +1,5 mm, pair	37-40	5 diag.	 1,5	<b>11776705</b> <b>17.24</b>				5	30

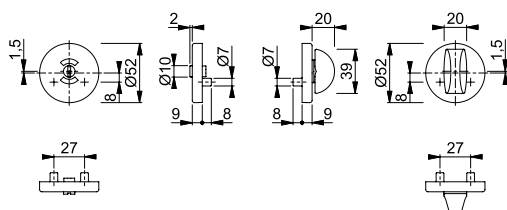







■ **42FIS**

duraplus®

HOPPE aluminium escutcheon with turn for entrance doors (interior side):

- Bearing: fixed/movable turn
- Connection: for 5 mm diagonal or 8 mm flat spindle
- Base: nylon
- Fixing: concealed, from inside, M5 thread screws that can be shortened

Description			Keyhole	F9714M				P.U.	O.C.
				Art. no./€					
Turn on rose, piece			5,5 	<b>11805663</b> <b>12.77</b>				50	50

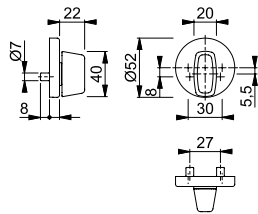





# Handle sets on mini rose





Quick-Fit

## Dallas - 1643/845

duraplus®

HOPPE aluminium handle set on mini rose without escutcheons for interior doors:

- Bearing: loose door handles, maintenance-free slide bearing
- Connection: **HOPPE Quick-Fit connection** with HOPPE solid spindle (spindle - receiver components)
- Fixing: plug-in mini roses
- Special feature: non-screw fitting

Description			F9714M				P.U.	O.C.
			Art. no./€					
Door handle set without escutcheon	35-45	8	<b>10803974</b> <b>47.29</b>				1	10
	35-55	8	11621849 <b>48.02</b>				1	10

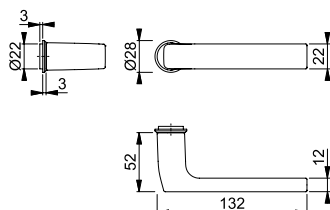

For DIN-standard-locks.





Quick-Fit

## Stockholm - 1140/845

duraplus®

HOPPE aluminium handle set on mini rose without escutcheons for interior doors:

- Bearing: loose door handles, maintenance-free slide bearing
- Connection: **HOPPE Quick-Fit connection** with HOPPE solid spindle (spindle - receiver components)
- Fixing: plug-in mini roses
- Special feature: non-screw fitting

Description			F9714M				P.U.	O.C.
			Art. no./€					
Door handle set without escutcheon	35-45	8	<b>11536305</b> <b>28.39</b>				1	10
	35-55	8	11650005 <b>29.12</b>				1	10

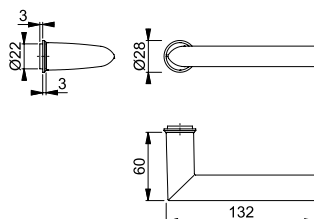

For DIN-standard-locks.









**M845S**

duraplus®

HOPPE brass mini-escutcheon pair with emergency release/turn for bathroom/WC doors:

- Connection: HOPPE solid spindle
- Fixing: with grub screw, additionally with silicone or adhesive



Description			Keyhole	F9714M				P.U.	O.C.
				Art. no./€					
Escutcheon, pair				11625028 <b>15.44</b>				5	25
Bathroom/WC escutcheon, pair	33-38	5-8		<b>10803835</b> <b>21.45</b>				5	25
	38-43			11605224 <b>21.45</b>			5	25	
	43-48			11621278 <b>21.45</b>			5	25	
	48-53			11621285 <b>21.45</b>			5	25	

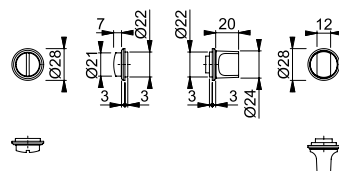

For DIN-standard-locks.







**M846S**

duraplus®

HOPPE brass mini-escutcheon pair for interior doors:

- Fixing: plug-in, additionally with silicone or adhesive
- Special feature: non-screw fitting



Description			Keyhole	F9714M				P.U.	O.C.
				Art. no./€					
Escutcheon, pair				<b>11550880</b> <b>15.44</b>				5	25
				10803827 <b>15.44</b>				5	25

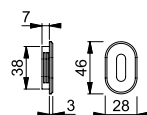

For DIN-standard-locks.







Secustik®  
VarioFit®

## Dallas - 0643/US944

duraplus®



HOPPE aluminium turn/tilt window handle with **Secustik®** and **VarioFit®**:

- Tested to **DIN EN 13126-3: 23/180-0150/03/C1** and **RAL-GZ 607/9**
- Stop-in position: 90°
- Cover: full cover cap
- Base: nylon, supporting lugs
- Spindle: HOPPE solid spindle, adjustable length of 10 mm, smooth adjustment thanks to the pressure spring integrated in the handle neck
- Fixing: concealed, M5 thread screws
- Special feature: built-in basic security



Description	Lugs Ø	Projecting Screws	F9714M		P.U.	O.C.
			Art. no./€			
Window handle, piece	10	7 32-42 M5 x 45/50	<b>11575840</b>	<b>21.24</b>	10	40

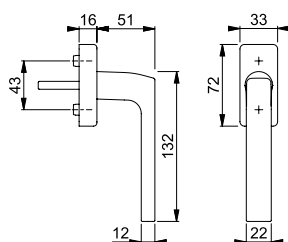

## Dallas - HS-0643/419N-AS

duraplus®



HOPPE aluminium lift/slide handle set for patio doors:

- Bearing: fixed/movable handles
- Stop-in position: 180°
- Base: zamak, supporting lugs
- Spindle: loose HOPPE solid spindle with radiused edges
- Fixing: concealed, bolt-through, M6 thread screws

Description	Keyhole/ Distance	F9714M		P.U.	O.C.
		Art. no./€			
Lift/slide handle set (handle/handle)	75-80 10x128	69	<b>11722277</b>	<b>113.36</b>	1 4

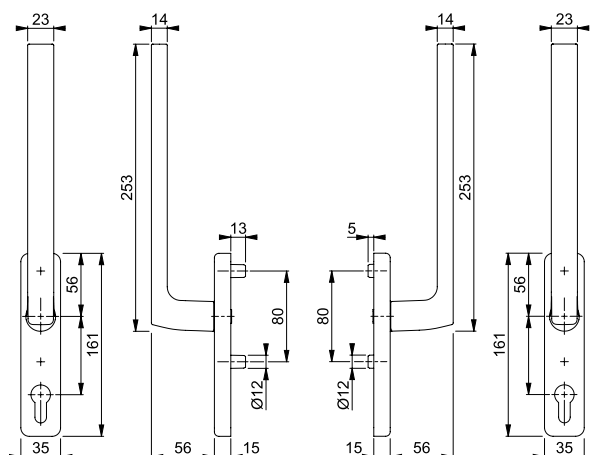



**Dallas - HS-0643/419N-AS/420**

duraplus®



HOPPE aluminium lift/slide handle set for patio doors, exterior with recessed pull:

- Bearing: fixed/movable handle
- Stop-in position: 180°
- Base: outside: none, inside: zamak, supporting lugs
- Spindle: loose HOPPE solid spindle with radiused edges
- Fixing: concealed, bolt-through, M6 thread screws

Description			Keyhole/ Distance	F9714M				P.U.	O.C.
				Art. no./€					
Lift/slide handle set (recessed pull/handle)	75-80	10x73		69	<b>11720755</b>			1	4
				with-out	11642270			1	4

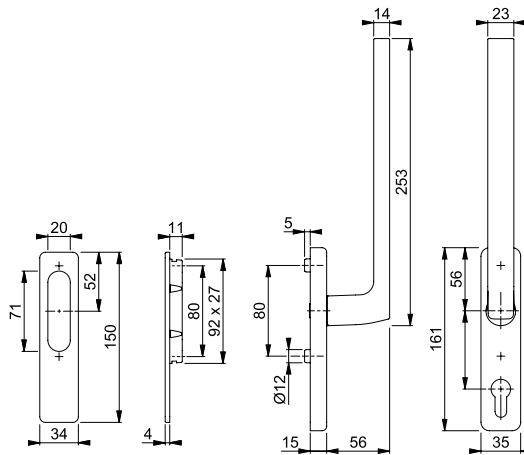

**London - 013VK/350KL**

duraplus®



HOPPE aluminium handle half set on backplate with turn for French doors:

- Bearing: fixed/movable, maintenance-free slide bearing
- Spindle: HOPPE solid spindle, turn with cross spindle
- Fixing: visible, for multi-purpose screws

Description	Keyhole/ Distance		Projecting Screws	F9714M				P.U.	O.C.
				Art. no./€					
Handle half set on backplate with turn, cranked right	60	8	without without	<b>11787284</b>				50	50
				11787272				50	50

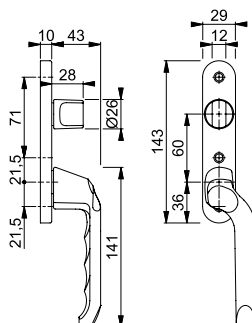

# Window handles and lift/slide handle sets

## London - 113/350KL

duraplus®



- HOPPE aluminum handle half set on backplate for French doors:
- Bearing: fixed/movable, maintenance-free slide bearing
  - Spindle: for HOPPE solid spindle with predetermined breaking point
  - Fixing: visible, for multi-purpose screws

Description	Keyhole/ Distance		Projecting Screws	F9714M Art. no./€			P.U.	O.C.
Handle half set on backplate	with-out	8	without without	<b>11788276</b> <b>10.35</b>			50	50

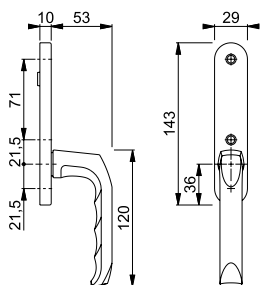

## Stockholm - 0140/US956

duraplus®



HOPPE aluminium turn/tilt window handle with **Secustik®** and **VarioFit®**:

- Tested to **DIN EN 13126-3: 23/180-0150/03/C1** and **RAL-GZ 607/9**
- Stop-in position: 90°
- Cover: full cover cap
- Base: nylon, supporting lugs
- Spindle: HOPPE solid spindle, adjustable length of 10 mm, smooth adjustment thanks to the pressure spring integrated in the handle neck
- Fixing: concealed, M5 thread screws
- Special feature: built-in basic security



Description	Lugs Ø		Projecting Screws	F9714M Art. no./€			P.U.	O.C.
Window handle, piece	10	7	32-42 M5 x 45/50	<b>11833051</b> <b>16.25</b>			10	40

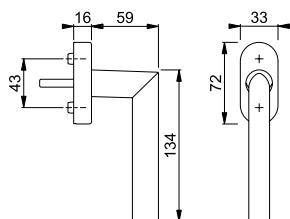

Secustik®  
VarioFit®

## Tôkyô - 0710S/U26

duraplus®



HOPPE aluminium lockable turn/tilt window handle:

- Locking mechanism: push cylinder, reversible key
- Stop-in position: 90°
- Cover: partial cover cap
- Base: nylon, supporting lugs
- Spindle: HOPPE solid spindle
- Fixing: concealed, M5 thread screws



Description	Lugs Ø		Projecting Screws	F9714M Art. no./€			P.U.	O.C.
Window handle, lockable, piece	10	7	35 M5 x 45	<b>10790528</b> <b>20.98</b>			10	40

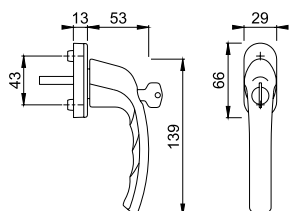



**Tōkyō - 0710/U26**

duraplus®

HOPPE aluminium turn/tilt window handle:

- Tested to **DIN EN 13126-3: 23/180-0150/03/C1** and **RAL-GZ 607/9**
- Stop-in position: 90°
- Cover: partial cover cap
- Base: nylon, supporting lugs
- Spindle: HOPPE solid spindle
- Fixing: concealed, M5 thread screws



Description	Lugs Ø		Projecting Screws	F9714M Art. no./€				P.U.	O.C.
Window handle, piece	10	7	58 M5 x 70	<b>11748285</b> <b>6.71</b>				100	100

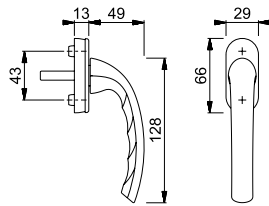

**Tōkyō - 0710EVKS/6**

duraplus®

HOPPE cranked lockable aluminium Espagnolette handle:

- Locking mechanism: push button locking cylinder, reversible key
- Stop-in position: none
- Cover: partial cover cap
- Base: aluminium, supporting lugs
- Spindle: HOPPE solid spindle
- Fixing: concealed, for M5 thread screws
- Special feature: for side-hung and top-hung outward opening windows, no tilt position, handle rotation up to 90°, non-lockable version with nylon cylinder cover cap (order separately)



Description	Lugs Ø		Projecting Screws	F9714M Art. no./€				P.U.	O.C.
Espagnolette handle, cranked right, lockable, piece	10	7	58 without	<b>11749428</b> <b>12.61</b>				50	50
Espagnolette handle, cranked left, lockable, piece	10	7	58 without	11749490 <b>12.61</b>				50	50

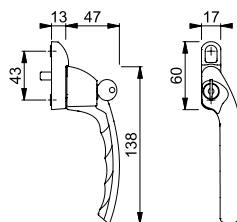



## ■ Tôkyô - 0710LVK/U71Z

duraplus®

HOPPE cranked aluminium window handle on narrow rosette:

- Stop-in position: none
- Cover: partial cover cap
- Base: zamak, supporting lugs
- Spindle: HOPPE solid spindle
- Fixing: concealed, for M5 thread screws
- Special feature: for outward-opening, pivoting windows, no tilt position, handle rotation angle up to 90°

Description	Lugs Ø	7	Projecting Screws	F9714M Art. no./€				P.U.	O.C.
Window handle with narrow rosette, cranked left, piece	10	7	58 without	11753328 9.18				100	100

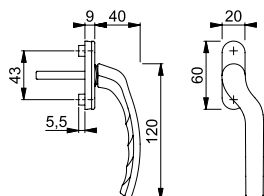

## ■ Tôkyô - 0710VK/93S

duraplus®

HOPPE cranked aluminium half handle set on security backplate for windows and French doors:

- Tested to **SS 3620:2010 - class B**
- Locking mechanism: for oval cylinder fixing by means of cylinder screw
- Spindle: HOPPE solid spindle with predetermined breaking point
- Fixing: visible, security screws



Description	Keyhole/ Distance	7	Projecting Screws	F9714M Art. no./€				P.U.	O.C.
Half handle set on security backplate, cranked right	67	7	43 4,5 x 40	11896498 41.52				16	16

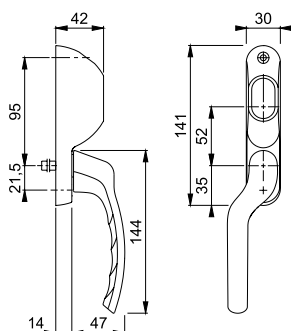





**Tôkyô - 0710VK/350KL**

duraplus®

HOPPE cranked aluminium handle half set on backplate for French doors:

- Bearing: fixed/movable, maintenance-free slide bearing
- Spindle: HOPPE solid spindle
- Stop-in position: 90°
- Fixing: visible, for multi-purpose screws

Description	Keyhole/ Distance		Projecting Screws	F9714M Art. no./€				P.U.	O.C.
Handle half set on backplate, cranked right	with-out	8	53	<b>11922874</b>				50	50
			without	<b>12.17</b>					
	with-out	8	without	11913137				50	50
			without	<b>11.62</b>					
Handle half set on backplate, cranked left		60	8	without	11799596			50	50
			without	<b>11.62</b>					
		60	8	without	11871441			50	50
			without	<b>12.06</b>					

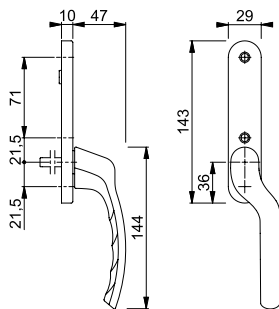





**Tôkyô - 0710VK/350KL**

duraplus®

HOPPE aluminium handle half set on backplate with turn for French doors:

- Bearing: fixed/movable, maintenance-free slide bearing
- Spindle: HOPPE solid spindle, turn with cross spindle
- Fixing: visible, for multi-purpose screws

Description	Keyhole/ Distance		Projecting Screws	F9714M Art. no./€				P.U.	O.C.
Handle half set on backplate with turn, cranked right		60	8	without	<b>11905955</b>			50	50
			without	<b>16.51</b>					
Handle half set on backplate with turn, cranked left		60	8	without	11786218			50	50
			without	<b>16.51</b>					
Handle half set on backplate with turn, cranked left		60	8	without	11799584			50	50
			without	<b>16.51</b>					
Handle half set on backplate with turn, cranked left		60	8	without	11905967			50	50
			without	<b>16.51</b>					

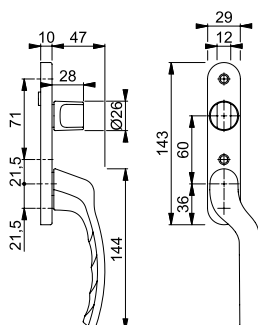



## Tôkyô - 0710VK/U14K

duraplus®

HOPPE cranked aluminium turn/tilt window handle on narrow rosette:

- Stop-in position: 90°
- Cover: partial cover cap
- Base: nylon, supporting lugs
- Spindle: HOPPE solid spindle
- Fixing: concealed, for M5 thread screws

Description	Keyhole/ Distance	Projecting Screws	F9714M Art. no./€	P.U.	O.C.
Window handle with narrow rosette, cranked right, piece	7	35 without	<b>2023943</b> <b>11.56</b>	10	100
Window handle with narrow rosette, cranked left, piece	7	35 without	2023978 <b>11.56</b>	10	100

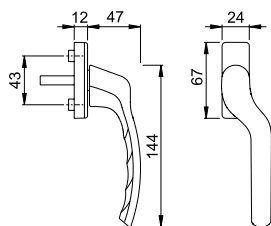

## Tôkyô - 1710RH/93S

duraplus®

HOPPE aluminium half handle set on security backplate for windows and French doors:

- Tested to **SS 3620:2010 - Klasse B**
- Locking mechanism: for oval cylinder fixing by means of cylinder screw
- Spindle: HOPPE solid spindle with predetermined breaking point
- Fixing: visible, security screws



Description	Keyhole/ Distance	Projecting Screws	F9714M Art. no./€	P.U.	O.C.
Half handle set on security backplate	67	35 4,5 x 40	<b>11915815</b> <b>41.52</b>	16	16
	67	8 53 4,5 x 40	11896413 <b>41.52</b>	16	16

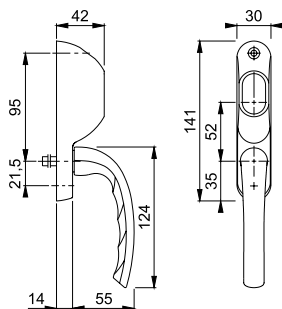



■ Tôkyô - 1710RH/350KL

duraplus®

HOPPE aluminum handle half set on backplate for French doors:

- Bearing: fixed/movable, maintenance-free slide bearing
- Spindle: for HOPPE solid spindle with predetermined breaking point
- Fixing: visible, for multi-purpose screws

Description	Keyhole/ Distance	Projecting Screws	F9714M				P.U.	O.C.
			Art. no./€					
Handle half set on backplate	with-out	8	without	<b>11799298</b>			50	50
	 60	8	without	11815838			50	50
			without	<b>11.62</b>				
			without	<b>11.62</b>				

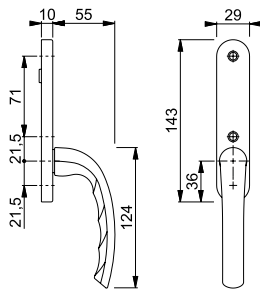



■ Tôkyô - 1710RH/350KL

duraplus®

HOPPE aluminium handle half set on backplate with turn for French doors:

- Bearing: fixed/movable, maintenance-free slide bearing
- Spindle: HOPPE solid spindle, turn with cross spindle
- Fixing: visible, for multi-purpose screws

Description	Keyhole/ Distance	Projecting Screws	F9714M				P.U.	O.C.
			Art. no./€					
Handle half set on backplate with turn	 60	8	without	<b>11815905</b>			50	50
	 60	8	without	11890046			50	50
			without	<b>16.51</b>				
			without	<b>16.51</b>				

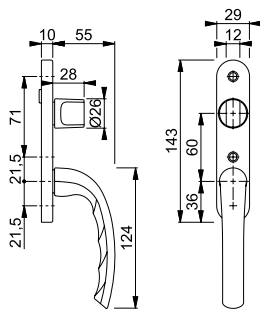

## Tôkyô - 1710RVH/350KL

duraplus®



HOPPE aluminum handle half set on backplate for French doors:

- Bearing: fixed/movable, maintenance-free slide bearing
- Spindle: for HOPPE solid spindle with predetermined breaking point
- Fixing: visible, for multi-purpose screws

Description	Keyhole/ Distance	Projecting Screws	F9714M Art. no./€	P.U.	O.C.
Handle half set on backplate	60	without without	<b>11870679</b> <b>14.66</b>	50	50

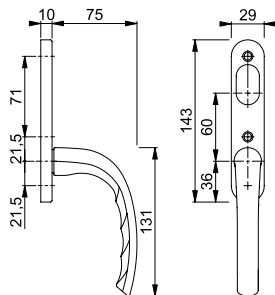

## Tôkyô - HS-571/431N-AS

duraplus®



HOPPE aluminium lift/slide handle set for patio doors:

- Bearing: fixed/movable handles
- Stop-in position: 180°
- Base: zamak, supporting lugs
- Spindle: loose HOPPE solid spindle with radiused edges
- Fixing: concealed, bolt-through, M6 thread screws

Description	Keyhole/ Distance	F9714M Art. no./€	P.U.	O.C.	
Lift/slide handle set (handle/handle)	75-80	10	Keyhole/ Distance 69	<b>11720761</b> <b>84.37</b>	1 4

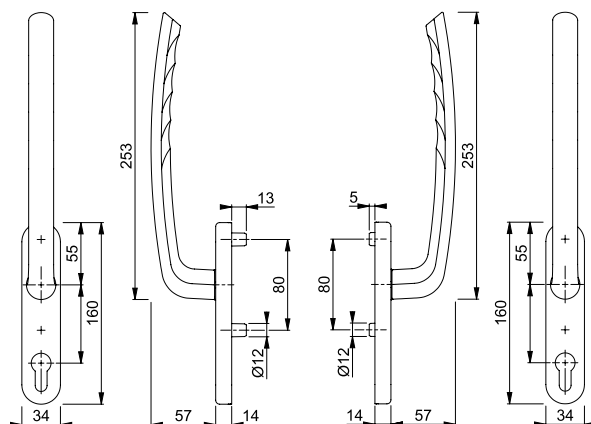







**Tōkyō - HS-571/431N-AS/420**

duraplus®

HOPPE aluminium lift/slide handle set for patio doors, exterior with recessed pull:

- Bearing: fixed/movable handle
- Stop-in position: 180°
- Base: outside: none, inside: zamak, supporting lugs
- Spindle: loose HOPPE solid spindle with radiused edges
- Fixing: concealed, bolt-through, M6 thread screws

Description			Keyhole/ Distance	F9714M				P.U.	O.C.
				Art. no./€					
Lift/slide handle set (recessed pull/handle)	75-80	10x73	 69	<b>11748291</b>				1	4
			with- out	11748315				1	4

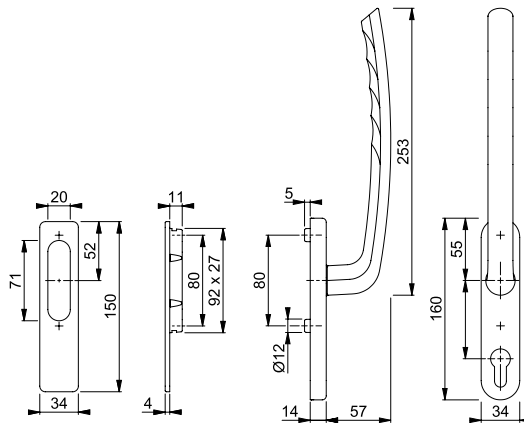

New



**Toulon - 0737S/US947-1 100NM**

duraplus®

HOPPE aluminium lockable turn/tilt window handle with **Secu100®** + **Secustik®** and **VarioFit®**:

- Tested to **DIN EN 13126-3: 23/180-0132/33/C1** and **RAL-GZ 607/9, RAL100**; meets the requirements of **DIN EN 1627-1630 RC1-6**
- Locking mechanism: push cylinder, reversible key
- Stop-in position: 90°
- Cover: partial cover cap
- Base: nylon, supporting lugs
- Spindle: HOPPE solid spindle
- Fixing: concealed, M5 thread screws
- Special feature: built-in basic security



**Secu100®**  
**Secustik®**  
**VarioFit®**

Description	Lugs Ø		Projecting Screws	F9714M				P.U.	O.C.
				Art. no./€					
Window handle, lockable, piece	10	7	32-42 M5 x 50/55	<b>11506246</b>				2	20

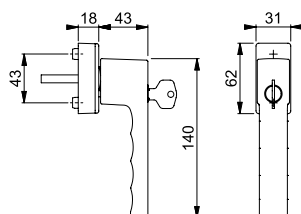



Secustik®  
VarioFit®

## Toulon - 0737/US947

duraplus®



HOPPE aluminium turn/tilt window handle with **Secustik®** and **VarioFit®**:

- Tested to **DIN EN 13126-3: 23/180-0150/03/C1** and **RAL-GZ 607/9**
- Stop-in position: 90°
- Cover: partial cover cap
- Base: nylon, supporting lugs
- Spindle: HOPPE solid spindle, adjustable length of 10 mm, smooth adjustment thanks to the pressure spring integrated in the handle neck
- Fixing: concealed, M5 thread screws
- Special feature: built-in basic security



Description	Lugs Ø	7	Projecting	F9714M				P.U.	O.C.
			Screws	Art. no./€					
Window handle, piece	10	7	32-42 M5 x 45/50	<b>10793251</b> <b>9.66</b>				10	60

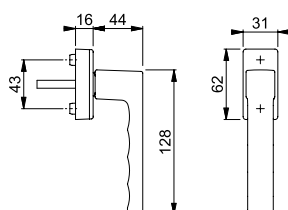

## Toulon - 0737/U34

duraplus®



HOPPE aluminium turn/tilt window handle:

- Tested to **DIN EN 13126-3: 23/180-0150/03/C1** and **RAL-GZ 607/9**
- Stop-in position: 90°
- Cover: partial cover cap
- Base: nylon, supporting lugs
- Spindle: HOPPE solid spindle
- Fixing: concealed, for M5 thread screws



Description	Lugs Ø	7	Projecting	F9714M				P.U.	O.C.
			Screws	Art. no./€					
Window handle, piece	10	7	58 without	<b>11748266</b> <b>8.10</b>				50	50

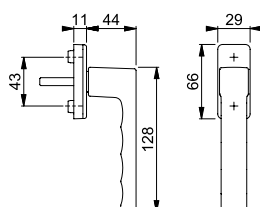

**Toulon - HS-0737/419N-AS**

duraplus®



HOPPE aluminium lift/slide handle set for patio doors:

- Bearing: fixed/movable handles
- Stop-in position: 180°
- Base: zamak, supporting lugs
- Spindle: loose HOPPE solid spindle with radiused edges
- Fixing: concealed, bolt-through, M6 thread screws

Description			Keyhole/ Distance	F9714M				P.U.	O.C.
				Art. no./€					
Lift/slide handle set (handle/handle)	75-80	10		69	<b>11645295</b>			1	4
Lift/slide handle half set (exterior side)		10		69	11668994			1	4
Lift/slide handle half set (interior side)		10		69	11668878			1	4
					with- out	11668745			1

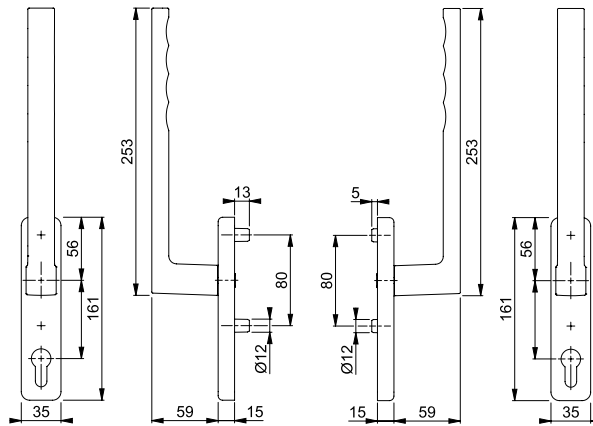

**Toulon - HS-0737/419N-AS/420**

duraplus®



HOPPE aluminium lift/slide handle set for patio doors, exterior with recessed pull:

- Bearing: fixed/movable handle
- Stop-in position: 180°
- Base: outside: none, inside: zamak, supporting lugs
- Spindle: loose HOPPE solid spindle with radiused edges
- Fixing: concealed, bolt-through, M6 thread screws

Description			Keyhole/ Distance	F9714M				P.U.	O.C.
				Art. no./€					
Lift/slide handle set (recessed pull/handle)	75-80	10x73		69	<b>11645635</b>			1	4
					with- out	11645325			1

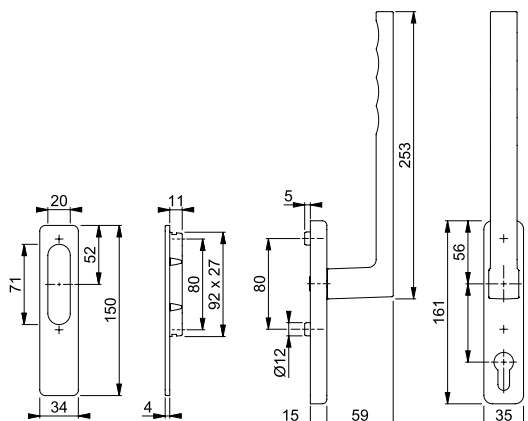

## ■ 350KL

duraplus®

HOPPE aluminium backplate for French doors:

- Fixing: visible, for multi-purpose screws

Description	Keyhole/ Distance		Projecting Screws	F9714M Art. no./€				P.U.	O.C.
Backplate without handle hole, piece	without		without	<b>11922965</b> <b>6.68</b>				20	100

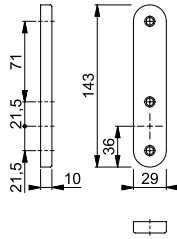



## 5004

duraplus®

HOPPE aluminium bar-shaped pull handle:

- Supports: cranked
- Fixing: concealed, pull handle fixing system no. 11

Description	Ø	Length	F9714M				P.U.	O.C.
		Distance	Art. no./€					
Bar-shaped pull handle, piece	25	330	<b>11620778</b>				1	5
		210	<b>99.32</b>					
		500	11690082				1	5
		210	<b>105.33</b>					

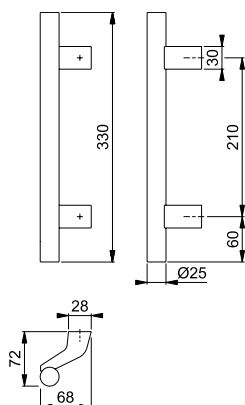

## Amsterdam - 6400

duraplus®

HOPPE aluminium straight pull handle:

- Fixing: concealed, pull handle fixing system no. 11

Description	Distance	F9714M				P.U.	O.C.
		Art. no./€					
Straight pull handle, piece	220	<b>11722332</b>				1	8
		<b>50.88</b>					

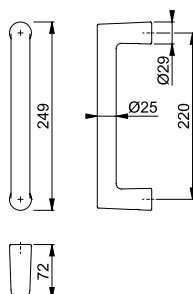

■ **6737**

duraplus®

HOPPE aluminium straight pull handle:

- Fixing: concealed, pull handle fixing system no. 11



Description	Distance	F9714M				P.U.	O.C.
		Art. no./€					
Straight pull handle, piece	250	<b>11722393</b> <b>49.84</b>				1	8

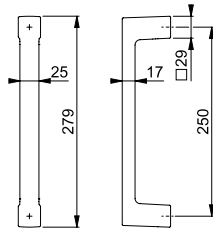













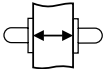

# General information

## Symbols

	OB (oval standard keyhole)
	PZ (profile cylinder)
	SK/OL (external: slotted head/internal: turn button)
	Door thickness (in mm)
	Spindle size (in mm)
	HOPPE divides its product range into three lines based on the customers' different requirements in price and perception of value – duravert®, duraplus® and duranorm®. The purpose behind this is to enable you, our partners, to get a better overview of our product range and to make it easier for you to find the right handle of excellence.

## Assessments for HOPPE products

 Produkten finns med i SundaHus Miljödata	SundaHus Material Data supports making environmentally conscious material choices within the construction and property markets. HOPPE aluminium and stainless steel door handles and aluminium pull handles are listed at SundaHus.
	Byggvarubedömningen is a non-profitable organization and its assessments are based on criteria concerning chemical content and life cycle aspects. BVB aims to support wise choices of material for a good living environment.
	HOPPE aluminium door-, window handles and accessories have received the status "recommended" at Byggvarubedömning.
	BASTA is a self-declaration system for registering products that meet the BASTA or BETA criteria requirement concerning substances with hazardous properties. HOPPE products do not contain chemicals that are dangerous for health and environment.

## Finish chart

 Aluminium



**F9714M**  
black matt















 Brass



**F9714M**  
black matt

## Brand, special and product attributes of the “HOPPE – Handle of excellence.” brand, certification marks

Regarding the “HOPPE – Handle of excellence.” brand product, the following product features are distinguished:

Denomination	Description	Attribute
<b>Brand attributes</b>	<ul style="list-style-type: none"> <li>distinguish all HOPPE products</li> <li>convey the brand promise</li> </ul>	 10-year guarantee on the mechanical operation  Made in Europe  DIN EN ISO 14001 Environmentally-considerate manufacturing
<b>Special attributes</b>	<ul style="list-style-type: none"> <li>underline a unique selling proposition or an essential additional benefit of the HOPPE brand product</li> </ul>	    
<b>Product attributes</b>	<ul style="list-style-type: none"> <li>present important information on a product or a benefit of the product</li> <li>are identified with the pictograms designed by HOPPE</li> </ul>	 Category of use grade 2 (3, 4) to DIN EN 1906  Category of use grade 2 to DIN EN 13126-3  Keyed locking  Solid brass  Very high corrosion resistance EN 1670, grade 4  Extremely high corrosion resistance EN 1670, grade 5

HOPPE Nordic Countries Oy  
Hyrylänkatu 8  
FI-04300 Tuusula  
Tel. +358 (0)9 25 84 34 24  
info.nordic@hoppe.com  
www.hoppe.com

HOPPE Nordic Countries i Sverige  
Post Box 29  
SE-566 21 Habo  
info.nordic@hoppe.com  
www.hoppe.com

---

## HOPPE business partners Nordic Countries

Business partner Sweden:

BESLAGSKONSULT AB  
Neongatan 11  
SE-431 53 Mölndal  
Tel. +46 (0)31 91 40 30  
Fax +46 (0)31 91 40 31  
info@beslagskonsult.se  
www.beslagskonsult.se

Business partner Finland:

Scancerco Oy  
Suvilahdenkatu 10B  
FIN-00500 Helsinki  
Tel. +358 (0)9 77 43 27 10  
Fax +358 (0)9 77 43 27 20  
myynti@scancerco.fi  
www.scancerco.fi

Business partner Denmark:

KH TRADE  
Theilgaards Allé 3A, "Den Hvide By"  
DK-4600 Køge  
Tel. +45 70 23 40 30  
Fax +45 70 23 40 31  
info@kh-trade.dk  
www.kh-trade.dk

Business partner Norway:

BOYESEN & MUNTHE A/S  
Haavard Martinsens Vei 19A  
NO-0978 Oslo  
Tel. +47 23 34 70 00  
Fax +47 23 34 70 19  
post@boyesen-munthe.no  
www.boyesen-munthe.no